

CSN-A3 Panel Printer' User Manual



Protocol: Zhu ChunYan 2018.04.24

Audit: Hu Riyu 2018.04.25

Standardize: Liu Zhonghua 2018.04.26

Authorize: Wang Huanyong 2018.04.26

Tel: 0592-5517253

Fax: 0592-5231815

Company Name: Xiamen Cashino Technology Co., Ltd.

Address: 4/F, No.318, Tongji South Road, Jimei District, Xiamen, China.361021

The manual is subject to change without further notice. Please contact Xiamen Cashino Technology Co., Ltd. directly for the latest version.

Content

Content.....	3
1.General Specifications.....	5
2.Features.....	5
3.Product Specification.....	6
3.1 Outline Dimention.....	6
4.Printer Parameters.....	6
5.Paper Installation.....	7
6.PIN Defined Of Interfaces.....	8
7.Care and maintenance.....	8
7.1 Daily maintenance of printer.....	9
7.2 Use and preservation of printing paper.....	9
8.Command Introduction.....	9
8.1Command List.....	9
8.2Commands details.....	10
①Printing and paper feed commands.....	10
Printing and paper feed.....	10
Enter.....	10
Print and paper feed n dots.....	11
Print and paper feed n line.....	11
②Printing set commands.....	11
Set line space as n dots.....	11
Set line space to default.....	12
Set absolute print position.....	12
Set the left margin.....	12
Set character printing method.....	13
Set character size.....	14
Set、 remove white printing.....	14
Set、 remove underline.....	15
Set、 remove 90°revolving printing.....	16
Set printing alignment.....	16
Set Chinese mode.....	17
Cancel Chinese character mode.....	17
Select、 cancel user customized characters.....	17
Define user customized characters.....	17
Cancel user customized characters.....	20
Selecting international character set.....	20
Select character code.....	21
③Graphic printing command.....	22
Fill Graphics vertical module data.....	22
Print Graphics horizontal module data.....	24
Define downloaded bitmap.....	25
Print downloaded bitmap.....	26

Define NV bitmap.....	27
Print NV bitmap.....	29
④Tab Commands.....	30
Horizontal tab.....	30
Horizontal tab position setting.....	31
⑤One-dimension bar code command.....	32
1D bar code readable character(HRI) print position setting.....	32
1D bar code height setting.....	32
1D bar code width setting.....	32
1D bar code printing.....	33
⑥Status querying Commands.....	38
Transmission status.....	38
Real-time transmission status.....	39
Real-time transmission status.....	39
⑦Two-dimensional bar code commands.....	42
Mode type of QR code.....	42
Setting error correction level of QR code.....	43
Store QR code data to QR code data buffer.....	43
Printing QR bar code.....	44
Setting QR code graph information.....	44
Printing two dimensional code.....	45
Printing double QR code.....	46
⑧Other commands.....	47
Printer reset.....	47
Print self-test page.....	47

1. General Specifications



Name: Micro Panel printer

Model: CSN-A3

Installation Port Size: 71.3 (W) *44.8 (H) mm

Insert Depth: 40.5/43.5mm

Application: Taxi meter print proposal, Recording Meter print proposal

Self-service Print proposal, Ticket Machine print proposal

Medical instrument print proposal, Weight Machine Print proposal

Electric Instrument Print proposal, Test Instrument Print proposal

2. Features

- ① Smart appearance
- ② Front panel make paper replacement easily
- ③ Easy paper loading
- ④ Low noise thermal printing
- ⑤ Different interfaces optional
- ⑥ Easily embedded to any kinds of instruments and meters

3.Product Specification

3.1 Outline Dimention

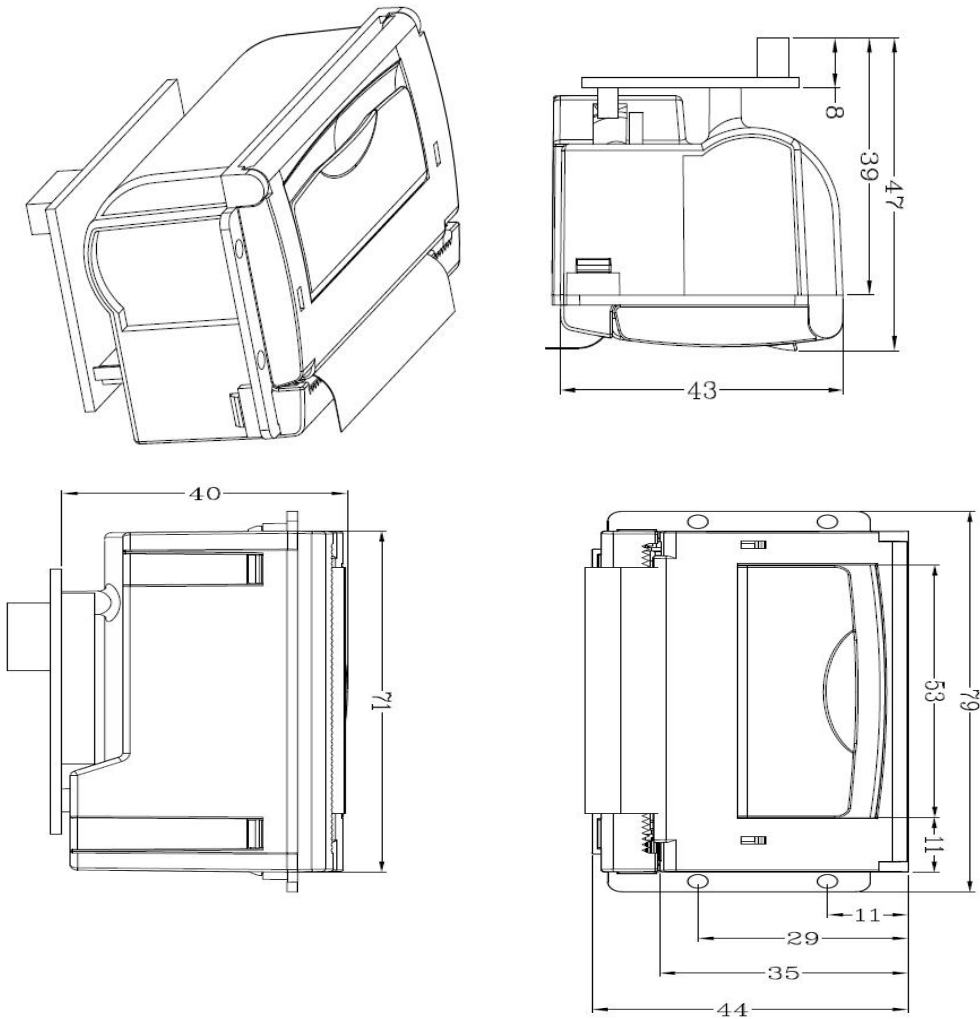

4.Printer Parameters

Print	Printing Method	Thermal Line
	Printing Speed	Max:90mm/s
	Resolution	203dpi(8dot/mm)
	Effective Printing Width	48mm
Character	Character Set	ASCII, GB2312-80 (Chinese)
	Print font	ANK: (8*16,9*17,9*24,12*24) Chinese: (16*16, 24*24)
	Paper Type	Thermal Paper

Paper spec.	Paper Width	57.5±0.5mm	
	Paper Roll Diameter	Max: 23mm	
Reliability	MCBF	> 5 million lines	
Interface		Serial (RS232, TTL) /USB	
Insert Depth		40.5/43.5mm	
Power Supply		DC 5V-9V ≥2A	12V ≥2A
Physical	Outline Dimention (W*L**H)	79*44*48mm	
	Installation Port Size	71.3*44.8mm	
	Color	Black/Beige	
Environment	Operating Temp	0°C ~ 50°C	
	Operating Humidity	20% ~ 85%RH	
	Storage Temp	-20°C ~ 60°C	
	Storage Humidity	5% ~ 90%RH	

5.Paper Installation

- 1.Open the printer cover;
- 2.Put in the paper roll, make sure the back side upward;
- 3.Close the printer cover, make the printing paper slightly exposed.

Note: Before installing the printing paper, please tear the gummed paper off the paper roll first, make sure there is no residual foreign matter to protect the printer head.



6.PIN Defined Of Interfaces

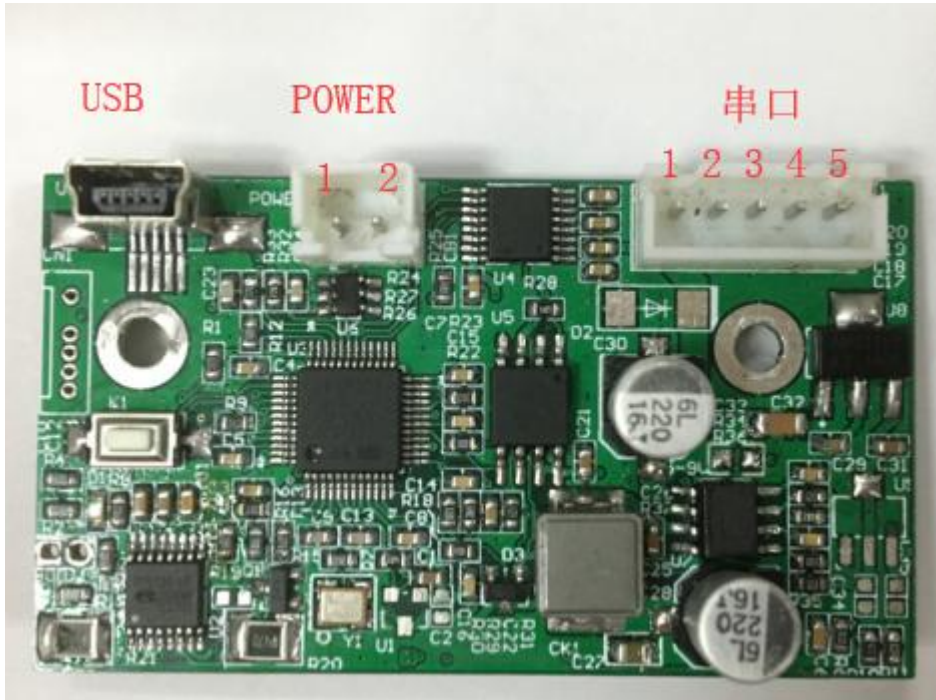

(1) USB Communication

CAN-A3 thermal printer has USB interface which changed to USB2.0 through mini USB.

(2) Power

PIN Number	Signal Name
1.GND	5(Ground)
2.VCC	5-9V/12V

(3) Serial Interface

PIN Number	Direction	Introduction
1.VCC		Input 5V-9V/12V direct current
2.DTR		Data Terminal Ready
3.TXD	Output	Transmit Data
4.RXD	Input	Receive Data
5.GND		Ground

7.Care and maintenance

7.1 Daily maintenance of printer

1.Printer's outside and paper warehouse cleaning : pls gently wipe the printer's outside and paper warehouse by wrung-out wet cloth .

2.Printer's mechanism cleaning : please make sure to clean printer's mechanism regularly, especially when the printing quality dropped.Cleaning way: gently wipe the print head with the absorbent cotton dipped in anhydrous alcohol until it is clean.

3.If the printer into the water, please turn it off immediately and dry the printer naturally.

7.2 Use and preservation of printing paper

1.Please don't put the paper roll where the sun is shining or high temperature. Please don't tear the wrapping paper before using.

2.The printed documents should be kept in where room temperature (around 20℃) and without light , thus can effectively extend the preservation time.

3.If users want to keep the receipts for a long time, please select our company's thermal paper roll.

8.Command Introduction

8.1Command List

LF	Line feed	Printing and paper feed commands
CR	Enter	
ESC J	Print and paper feed n dots	
ESC d	Print and paper feed n lines	Print setting commands
ESC 3	Set line space n dots	
ESC 2	Set default line space	
ESC \$	Set print position	
GS L nL nH	Set left margin amount	
ESC !	Set character printing method	
GS ! n	Set character size	
GS B n	Set and delete white printing	
ESC - n	Set and delete underline	
ESC V n	Set and delete 90°rotate printing	
ESC a	Setting position alignment mode	
FS &	Set Chinese character mode	
FS .	Delete Chinese character mode	
ESC % n	Choose and delete customized characters	
ESC &	Define customized characters	
ESC ? n	Delete customized character	
ESC R n	International character sets	
ESC t n	Select the character code page	
ESC *	Bitmap vertical modulus data fillings	Bitmap Commands
GS v 0	Bitmap horizontal modulus data print	
GS *	Define download bitmap	

GS / m	Print download bitmap	
FS q	Define NV bitmap	
FS p n m	Print NV bitmap	
HT	Horizontal tab	
ESC D	Set horizontal tabulation position	Tab Commands
GS H	Set 1-D barcode readable character(HRI) print position	1-D Barcoe Print Commands
GS h	Set 1-D barcoe hight	
GS w	Set 1-D barcode width	
GS k	1-D barcode	
GS (2-D barcode print	2-D Barcoe Print Commands
GS r n	Transmission status	Status Checking Commands
DLE EOT n	Real-time transmission status	
ESC @	Printer reset	Other commands
DC2 T	Printing self-test page	

8.2 Commands details

① Printing and paper feed commands

Printing and paper feed

Name	print and paper feed
Code	ASCII : LF DEC : 10 HEX : 0A
Function	Print the buffer contest,and set the paper feed as per line space,then adjust print position to initial position at the next line.
Range	None
Default	None
Notes	None
Example	None

Enter

Name	Enter
Code	ASCII : CR DEC : 13 HEX : 0D
Function	Adjust print position to initial position of the same line.
Range	None
Default	None
Notes	After executing, R command, the new printing data will cover old data in the printing buffer.

Example	None
---------	------

Print and paper feed n dots

Name	Print and paper feed n dots
Code	ASCII : ESC J n DEC : 27 74 n HEX : 1B 4A n
Function	Print the buffer content and paper feed
Range	$0 \leq n \leq 255$
Default	None
Notes	Paper feed n dots when printing buffer is empty. After executing this command,printing position is moved to initial
Example	1b 40 30 31 32 1b 4a 10

Print and paper feed n line

Name	Print and paper feed n lines
Code	ASCII : ESC d n DEC : 27 100 n HEX : 1B 64 n
Function	Print the contents in printing buffer and paper feed n lines.
Range	$0 \leq n \leq 255$
Default	None
Notes	Print this command set as initial position of the same line
Example	1b 40 30 31 32 1b 64 01

②Printing set commands

Set line space as n dots

Name	Set line space as n dots
Code	ASCII : ESC 3 n DEC : 27 51 n HEX : 1B 33 n
Function	Set line space as n dots
Range	$0 \leq n \leq 255$
Default	n = 33
Notes	<p>Line space as below:</p> <p>If the line space setted is less than the highest character in that line,then this line space is equal to the height of the highest character.</p> <p>If ESC2,ESC@,reset the printer, the printer blackout,and the line space turns to default.</p>

Example	1b 40
	1b 33 30
	30 31 32 0d 0a
	30 31 32 0d 0a
	1b 32
	30 31 32 0d 0a
	30 31 32 0d 0a

Set line space to default

Name	Set line space to default
Code	ASCII : ESC 2
	DEC : 27 50
	HEX : 1B 32
Function	Set line space to default 30 dots
Range	None
Default	None
Notes	<p>Line space in details pls check ESC 3 command.</p> <p>If the line space setted is less than the height character in the line,the line space of this line is equal to the height of the highest character</p> <p>It can use ESC 3 to define line space.</p>
Example	None

Set absolute print position

Name	Set absolute print position
Code	ASCII : ESC \$ nL nH
	DEC : 27 36 nL nH
	HEX : 1B 24 nL nH
Function	Set left side blank area as $(nL + nH \times 256)$ dots
Range	$0 \leq nL \leq 255$
	$0 \leq nH \leq 255$
Default	None
Notes	<p>Set left side blank area as $[(nL+nH*256)]*0.125\text{mm}$</p> <p>This command is only effective with the initial position of the line.</p> <p>This command is unavailable if it sets beyond the printing area.</p>
Example	None

Set the left margin

Name	Set the left margin
Code	ASCII : GS L nL nH
	DEC : 29 76 nL nH
	HEX : 1D 4C nL nH
Function	Set the left margin as $(nL + nH \times 256)$ dots
Range	$0 \leq nL \leq 255, 0 \leq nH \leq 255$
Default	None

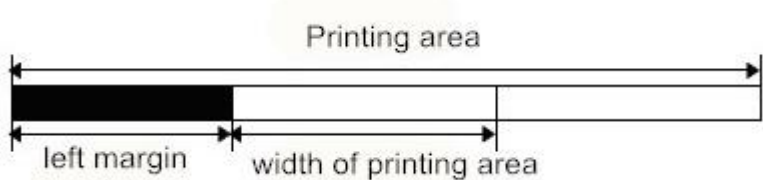
Support Model	All
Notes	<p>This command is only effective with the initial position of the line. The illustration is as follows:</p>  <p>The diagram shows a horizontal line representing a printing area. A black shaded rectangle on the left is labeled 'left margin'. A double-headed arrow below the line is labeled 'width of printing area', spanning from the end of the left margin to the right edge of the line. The entire line is labeled 'Printing area' above it.</p> <p>Use the maximum value of the printable unit,if the setting is beyond the printable area.</p>
Example	<pre>1b 40 1d 4c 08 00 30 31 32 0d 0a 30 31 32 0d 0a</pre>

Set character printing method

Name	Set character printing method																													
Code	<pre>ASCII : ESC ! n DEC : 27 33 n HEX : 1B 21 n</pre>																													
Function	<p>Set character printing methods (font,highlight,inversion,bold,double hight,double width and underline),parameter n bit definition as below:</p> <table border="1"> <thead> <tr> <th rowspan="2">Bit Function</th> <th colspan="2">Value</th> </tr> <tr> <th>0</th> <th>1</th> </tr> </thead> <tbody> <tr> <td>0 Font</td> <td>Normal</td> <td>Small character</td> </tr> <tr> <td>1 Undefined</td> <td></td> <td></td> </tr> <tr> <td>2 Undefined</td> <td></td> <td></td> </tr> <tr> <td>3 Bold</td> <td>Cancel</td> <td>Setting</td> </tr> <tr> <td>4 Double hight</td> <td>Cancel</td> <td>Setting</td> </tr> <tr> <td>5 Double width</td> <td>Cancel</td> <td>Setting</td> </tr> <tr> <td>6 Undefined</td> <td></td> <td></td> </tr> <tr> <td>7 Underline</td> <td>Cancel</td> <td>Setting</td> </tr> </tbody> </table>	Bit Function	Value		0	1	0 Font	Normal	Small character	1 Undefined			2 Undefined			3 Bold	Cancel	Setting	4 Double hight	Cancel	Setting	5 Double width	Cancel	Setting	6 Undefined			7 Underline	Cancel	Setting
Bit Function	Value																													
	0	1																												
0 Font	Normal	Small character																												
1 Undefined																														
2 Undefined																														
3 Bold	Cancel	Setting																												
4 Double hight	Cancel	Setting																												
5 Double width	Cancel	Setting																												
6 Undefined																														
7 Underline	Cancel	Setting																												
Range	None																													
Default	n = 0																													
Notes	<p>The command is effective with Chinese and foreign languages. The command is disabled when ESC@, printer reset or power off</p>																													
Example	<pre>1B 40 1B 21 01 30 31 32 0D 0A 1B 40 1B 21 02 30 31 32 0D 0A 1B 40 1B 21 04 30 31 32 0D 0A 1B 40 1B 21 08 30 31 32 0D 0A 1B 40 1B 21 10 30 31 32 0D 0A 1B 40 1B 21 20 30 31 32 0D 0A 1B 40 1B 21 40 30 31 32 0D 0A</pre>																													

	1B 40 1B 21 80 30 31 32 0D 0A
--	-------------------------------

Set character size

Name	Set character size																																																						
Code	ASCII : GS ! n DEC : 29 33 n HEX : 1d 21 n																																																						
Function	Set character size as 1-8 times width,1-8 times height. Definition is as below: Use 0-3 set character height 4 - 7 bits set character width show as below: <div style="display: flex; justify-content: space-around;"> <div style="text-align: center;"> <p>Chart 1</p> <p>Character width setting</p> <table border="1"> <thead> <tr> <th>HEX</th> <th>DEC</th> <th>width</th> </tr> </thead> <tbody> <tr><td>00</td><td>0</td><td>1(Normal)</td></tr> <tr><td>10</td><td>16</td><td>2(double width)</td></tr> <tr><td>20</td><td>32</td><td>3</td></tr> <tr><td>30</td><td>48</td><td>4</td></tr> <tr><td>40</td><td>64</td><td>5</td></tr> <tr><td>50</td><td>80</td><td>6</td></tr> <tr><td>60</td><td>96</td><td>7</td></tr> <tr><td>70</td><td>112</td><td>8</td></tr> </tbody> </table> </div> <div style="text-align: center;"> <p>Chart 2</p> <p>Character height setting</p> <table border="1"> <thead> <tr> <th>HEX</th> <th>DEC</th> <th>height</th> </tr> </thead> <tbody> <tr><td>00</td><td>0</td><td>1(Normal)</td></tr> <tr><td>01</td><td>1</td><td>2(double height)</td></tr> <tr><td>02</td><td>2</td><td>3</td></tr> <tr><td>03</td><td>3</td><td>4</td></tr> <tr><td>04</td><td>4</td><td>5</td></tr> <tr><td>05</td><td>5</td><td>6</td></tr> <tr><td>06</td><td>6</td><td>7</td></tr> <tr><td>07</td><td>7</td><td>8</td></tr> </tbody> </table> </div> </div>	HEX	DEC	width	00	0	1(Normal)	10	16	2(double width)	20	32	3	30	48	4	40	64	5	50	80	6	60	96	7	70	112	8	HEX	DEC	height	00	0	1(Normal)	01	1	2(double height)	02	2	3	03	3	4	04	4	5	05	5	6	06	6	7	07	7	8
HEX	DEC	width																																																					
00	0	1(Normal)																																																					
10	16	2(double width)																																																					
20	32	3																																																					
30	48	4																																																					
40	64	5																																																					
50	80	6																																																					
60	96	7																																																					
70	112	8																																																					
HEX	DEC	height																																																					
00	0	1(Normal)																																																					
01	1	2(double height)																																																					
02	2	3																																																					
03	3	4																																																					
04	4	5																																																					
05	5	6																																																					
06	6	7																																																					
07	7	8																																																					
Range	None																																																						
Default	n = 0																																																						
Notes	This command is effective with Chinese and other foreign languages, except for HRI character. The command setting is disable when ESC@, printer reset or power off.																																																						
Example	1b 40 1d 21 11 30 31 32 0d 0a 30 31 32 0d 0a																																																						

Set、 remove white printing

Name	Set、 remove white printing
Code	ASCII : GS B n DEC : 29 66 n HEX : 1d 42 n
Function	Set and remove white printing When the LSB of n is 0,white printing mode is off. When the LSB of n is 1,white printing mode is on.
Range	None
Default	n = 0
Notes	It is only effective for LSB of n.

	<p>This command is all effective with built-in characters and user-defined characters.</p> <p>It is effective with blank, which is setted by ESC CP, when white printing mode is on.</p> <p>This command is not effective with bitmap, user-defined bitmap, barcode, HRI character and vaulting space of HT, ESC \$.</p> <p>This command is not effective with line space.</p> <p>The white printing mode is prior to underline mode. When it is white printing mode, even underline mode is open, which can also be forbidden. (But it not be canceled).</p> <p>This command is disabled when ESC@, printer reset or power off.</p>
Example	<pre>1b 40 1d 42 01 30 31 32 0d 0a 30 31 32 0d 0a</pre>

Set、 remove underline

Name	Set、 remove underline								
Code	ASCII : ESC - n DEC : 27 45 n HEX : 1B 2D n								
Function	Set / remove underline mode, based on the value of n as follow: <table border="1" data-bbox="395 1093 1023 1283"> <thead> <tr> <th>n</th> <th>Functions</th> </tr> </thead> <tbody> <tr> <td>0, 48</td> <td>Remove underline mode</td> </tr> <tr> <td>1, 49</td> <td>Set underline mode(1 dot coarse)</td> </tr> <tr> <td>2, 50</td> <td>Set underline mode(2 dot coarse)</td> </tr> </tbody> </table>	n	Functions	0, 48	Remove underline mode	1, 49	Set underline mode(1 dot coarse)	2, 50	Set underline mode(2 dot coarse)
n	Functions								
0, 48	Remove underline mode								
1, 49	Set underline mode(1 dot coarse)								
2, 50	Set underline mode(2 dot coarse)								
Range	$0 \leq n \leq 2, 48 \leq n \leq 50$								
Default	n = 0								
Notes	<p>Printer can print underline for all characters (including the space to the right of the character), except for the space set by HT.</p> <p>Printer can not print underline for clockwise rotated 90° characters and white printing characters.</p> <p>When n is setted as 0 or 48, remove underline mode. Other data is not printed as underline, and the setted underline coarseness does not change before removing underline mode. The default underline coarseness is 1 dot.</p> <p>It is not effective with underline coarseness to change character size.</p> <p>Using ESC! can also set and remove underline mode. However be aware that the last received command must be effective.</p>								
Example	<pre>1b 40 1b 2d 01 30 31 32 0d 0a 1b 40 1b 2d 02 30 31 32 0d 0a 1b 40 1b 2d 00 30 31 32 0d 0a</pre>								

Set、 remove 90°revolving printing

Name	Set 、 remove 90°revolving printing
Code	ASCII : ESC V n DEC : 27 86 n HEX : 1B 56 n
Function	Set or remove 90° revolving printing When n is equal to 0 or 48,remove 90°revolving printing. When n is equal to 1 or 49,set 90°revolving printing.
Range	$0 \leq n \leq 1$, $48 \leq n \leq 49$
Default	n = 0
Support Model	All
Notes	<p>When it is setted to underline mode, the printer is not underlined for characters rotated 90°.</p> <p>In the 90° rotation mode, the multiplier and double width commands magnify the character in the opposite direction to the multiplier command in the normal mode.</p> <p>When ESC @, printer reset, power off, the setting of this instruction is invalid.</p>
Example	1b 40 1b 56 01 30 31 32 0d 0a 30 31 32 0d 0a

Set printing alignment

Name	Set print alignment (Left, middle, right)								
Code	ASCII : ESC a n DEC : 27 97 n HEX : 1B 61 n								
Function	Align all data in one line,the meaning of n value as below: <table style="margin-left: 40px;"> <tr> <td>n</td> <td>mode</td> </tr> <tr> <td>0, 48</td> <td>left</td> </tr> <tr> <td>1, 49</td> <td>middle</td> </tr> <tr> <td>2, 50</td> <td>right</td> </tr> </table>	n	mode	0, 48	left	1, 49	middle	2, 50	right
n	mode								
0, 48	left								
1, 49	middle								
2, 50	right								
Range	$0 \leq n \leq 2$ or $48 \leq n \leq 50$								
Default	n = 0								
Notes	This command setting is disabled when ESC@,printer resets or power off.								
Example	1B 40 1B 61 02 30 31 32 0D 0A 1B 40 1B 61 01 30 31 32 0D 0A 1B 40 1B 61 00 30 31 32 0D 0A								

Set Chinese mode

Name	Set Chinese mode
Code	ASCII : FS & DEC : 28 38 HEX : 1C 26
Function	Set Chinese mode
Range	None
Default	None
Notes	When the Chinese character mode is selected, the printer processes all Chinese character codes(ASCII code) , two bytes at a time. The Chinese character code(ASCII code) is processed in the order of the first byte and the second byte.
Example	1b 40 1C 26 B0 AE C9 CF D7 D4 BC BA 0d 0a 1C 2E B0 AE C9 CF D7 D4 BC BA 0d 0a

Cancel Chinese character mode

Name	Cancel Chinese character mode
Code	ASCII : FS . DEC : 28 46 HEX : 1C 2E
Function	Cancel Chinese character mode
Range	None
Default	None
Notes	None
Example	None

Select、cancel user customized characters

Name	Select 、cancel user customized characters
Code	ASCII : ESC % n DEC : 27 37 n HEX : 1B 25 n
Function	Select 、cancel user customized characters When n LSB is 0, delete customized characters When n LSB is 1, select customized characters
Range	$0 \leq n \leq 255$
Default	0
Notes	When cancel customized characters, automatically select the internal character set.
Example	None

Define user customized characters

Name	Define user customized characters
------	-----------------------------------

Code	ASCII : ESC & y c1 c2 [x1 d1 ... d (yx1)] ... [xk d1 ... d(y x k)] DEC : 27 38 y c1 c2 [x1 d1 ... d(yx1)] ...[xk d1 ... d(yxk)] HEX : 1B 26 y c1 c2 [x1 d1...d(y x1)]...[xk d1...d(yxk)]
Function	Define user customized characters. y specifies vertical direction bytes. c1 specifies the starting character encoding,c2 specifies the ending character encoding xk specifies horizontal direction dots.
Range	The range of x 、 y, are correspond with internal fonts. If choosing Font 6*12, y = 2, 0 ≤ x ≤ 6 If choosing Font 12*24, y= 3, 0 ≤ x ≤ 12 32 ≤ c1 ≤ c2 ≤ 126 0 ≤ d1 ... d(y*xk) ≤ 255
Default	None
Notes	Definable character code range:from<20>H to <7E>H ASCII code(95 characters). It can define continuous characters encoding for several characters.When it need one character only,make c1=c2. d is character's dot data,dot mode starts from left side in the horizontal direction.It is blank for the rest dots in the right side. Defined user defines characters data is (y*x) byte. Set corresponding bit of printing dots as 1, or corresponding bit of no printing dots as 0. This command defines different customized characters for each type of font. Set font with ESC !. Customized characters and downlink bitmaps cannot be defined at the same time. When the command is executed, the downlink bitmap is cleared. User Customized characters will be cleared in these situations: Execute ESC @。 Execute GS *。 Execute ESC ?。 Printer reset or power off Graphic: When set font A(12 24).

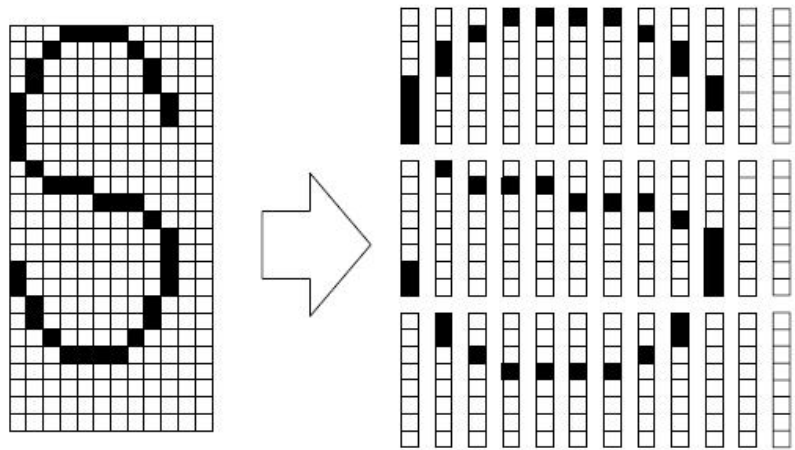
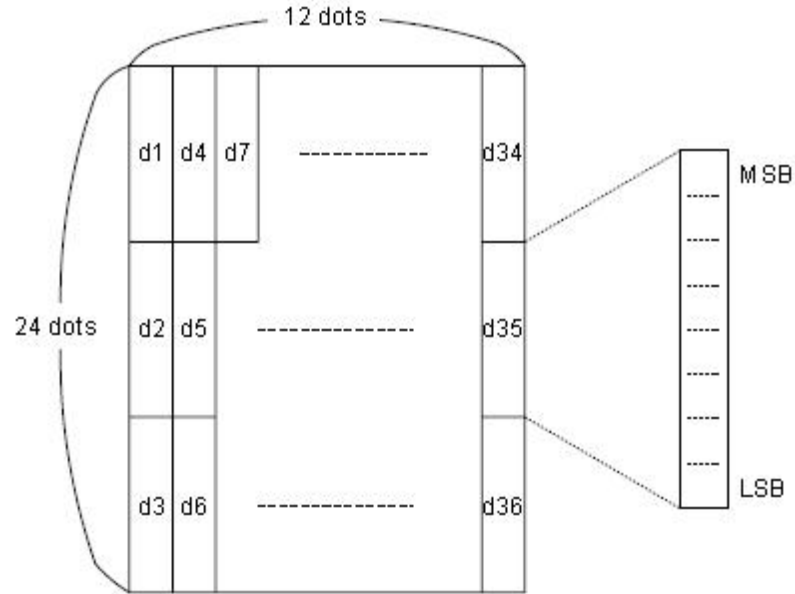

d1 = <0F>H d4 = <30>H d7 = <40>H
 d2 = <03>H d5 = <80>H d8 = <40>H
 d3 = <00>H d6 = <00>H d9 = <20>H

<p>Example</p>	<p>①y = 2 1B 40 1b 26 02 20 20 06 FF FF FF FF FF FF FF FF FF FF FF 1b 25 01 20 20 0D 0A 1b 3f 20 30 20 30 20 0d 0a</p> <p>②y = 3 1B 40 1b 26 03 20 20 06 FF FF FF FF FF FF FF FF FF FF FF FF FF FF FF FF 1b 25 01 20 20 0D 0A</p>
----------------	--

	1b 3f 20 30 20 30 20 0d 0a
--	-------------------------------

Cancel user customized characters

Name	Cancel user customized characters
Code	ASCII : ESC ? n DEC : 27 63 n HEX : 1B 3F n
Function	Cancel user customized characters of specified code by n
Range	$32 \leq n \leq 126$
Default	None
Notes	This command terminates the use of styles defined for character encoding, which is specified by n. After the user customized character is canceled, it is printed in the corresponding mode of the internal character. In the font selected with ESC !, the command removes the style defined for the specified encoding. If a user customized character is not defined, the printer ignores the command.
Example	None

Selecting international character set

Name	Selecting international character set																																		
Code	ASCII : ESC R n DEC : 27 82 n HEX: 1B 52 n																																		
Function	Selecting international character set n from the following table: <table style="margin-left: 40px;"> <tr> <td>n</td> <td>Character</td> </tr> <tr> <td>0</td> <td>U.S.A</td> </tr> <tr> <td>1</td> <td>France</td> </tr> <tr> <td>2</td> <td>Germany</td> </tr> <tr> <td>3</td> <td>U.K</td> </tr> <tr> <td>4</td> <td>Denmark I</td> </tr> <tr> <td>5</td> <td>Sweden</td> </tr> <tr> <td>6</td> <td>Italy</td> </tr> <tr> <td>7</td> <td>Spain I</td> </tr> <tr> <td>8</td> <td>Japan</td> </tr> <tr> <td>9</td> <td>Norway</td> </tr> <tr> <td>10</td> <td>Denmark II</td> </tr> <tr> <td>11</td> <td>Spain II</td> </tr> <tr> <td>12</td> <td>Latin America</td> </tr> <tr> <td>13</td> <td>Korea</td> </tr> <tr> <td>14</td> <td>Slovenia</td> </tr> <tr> <td>15</td> <td>China</td> </tr> </table>	n	Character	0	U.S.A	1	France	2	Germany	3	U.K	4	Denmark I	5	Sweden	6	Italy	7	Spain I	8	Japan	9	Norway	10	Denmark II	11	Spain II	12	Latin America	13	Korea	14	Slovenia	15	China
n	Character																																		
0	U.S.A																																		
1	France																																		
2	Germany																																		
3	U.K																																		
4	Denmark I																																		
5	Sweden																																		
6	Italy																																		
7	Spain I																																		
8	Japan																																		
9	Norway																																		
10	Denmark II																																		
11	Spain II																																		
12	Latin America																																		
13	Korea																																		
14	Slovenia																																		
15	China																																		
Range	$0 \leq n \leq 15$																																		
Default	0																																		

Notes	None
Example	1B 40 1B 52 00 20 21 22 23 24 25 26 27 28 29 2A 2B 2C 2D 2E 2F 30 31 32 33 34 35 36 37 38 39 3A 3B 3C 3D 3E 3F 40 41 42 43 44 45 46 47 48 49 4A 4B 4C 4D 4E 4F 50 51 52 53 54 55 56 57 58 59 60 6A 6B 6C 6D 6E 6F 70 71 72 73 74 75 76 78 79 7A 7B 7C 7D 7E 0D 0A

Select character code

Name	Select character code																																																												
Code	ASCII : ESC t n DEC : 27 116 n HEX : 1B 74 n																																																												
Function	Selects n from character code <table> <thead> <tr> <th>N</th> <th>Code Page</th> </tr> </thead> <tbody> <tr><td>0</td><td>CP437 [U.S.A., Standard Europe]</td></tr> <tr><td>1</td><td>KataKana</td></tr> <tr><td>2</td><td>CP850 [Multilingual]</td></tr> <tr><td>3</td><td>CP860 [Portuguese]</td></tr> <tr><td>4</td><td>CP863 [Canadian-French]</td></tr> <tr><td>5</td><td>CP865 [Nordic]</td></tr> <tr><td>6</td><td>WCP1251 [Cyrillic]</td></tr> <tr><td>7</td><td>CP866 Cyrillic #2</td></tr> <tr><td>8</td><td>MIK [Cyrillic /Bulgarian]</td></tr> <tr><td>9</td><td>CP755 [East Europe, Latvian 2]</td></tr> <tr><td>10</td><td>Iran</td></tr> <tr><td>11</td><td>Reserve</td></tr> <tr><td>12</td><td>Reserve</td></tr> <tr><td>13</td><td>Reserve</td></tr> <tr><td>14</td><td>Reserve</td></tr> <tr><td>15</td><td>CP862 [Hebrew]</td></tr> <tr><td>16</td><td>WCP1252 Latin I</td></tr> <tr><td>17</td><td>WCP1253 [Greek]</td></tr> <tr><td>18</td><td>CP852 [Latina 2]</td></tr> <tr><td>19</td><td>CP858 Multilingual Latin I +Euro)</td></tr> <tr><td>20</td><td>Iran II</td></tr> <tr><td>21</td><td>Latvian</td></tr> <tr><td>22</td><td>CP864 [Arabic]</td></tr> <tr><td>23</td><td>ISO-8859-1 [West Europe]</td></tr> <tr><td>24</td><td>CP737 [Greek]</td></tr> <tr><td>25</td><td>WCP1257 [Baltic]</td></tr> <tr><td>26</td><td>Thai</td></tr> <tr><td>27</td><td>CP720[Arabic]</td></tr> <tr><td>28</td><td>CP855</td></tr> </tbody> </table>	N	Code Page	0	CP437 [U.S.A., Standard Europe]	1	KataKana	2	CP850 [Multilingual]	3	CP860 [Portuguese]	4	CP863 [Canadian-French]	5	CP865 [Nordic]	6	WCP1251 [Cyrillic]	7	CP866 Cyrillic #2	8	MIK [Cyrillic /Bulgarian]	9	CP755 [East Europe, Latvian 2]	10	Iran	11	Reserve	12	Reserve	13	Reserve	14	Reserve	15	CP862 [Hebrew]	16	WCP1252 Latin I	17	WCP1253 [Greek]	18	CP852 [Latina 2]	19	CP858 Multilingual Latin I +Euro)	20	Iran II	21	Latvian	22	CP864 [Arabic]	23	ISO-8859-1 [West Europe]	24	CP737 [Greek]	25	WCP1257 [Baltic]	26	Thai	27	CP720[Arabic]	28	CP855
N	Code Page																																																												
0	CP437 [U.S.A., Standard Europe]																																																												
1	KataKana																																																												
2	CP850 [Multilingual]																																																												
3	CP860 [Portuguese]																																																												
4	CP863 [Canadian-French]																																																												
5	CP865 [Nordic]																																																												
6	WCP1251 [Cyrillic]																																																												
7	CP866 Cyrillic #2																																																												
8	MIK [Cyrillic /Bulgarian]																																																												
9	CP755 [East Europe, Latvian 2]																																																												
10	Iran																																																												
11	Reserve																																																												
12	Reserve																																																												
13	Reserve																																																												
14	Reserve																																																												
15	CP862 [Hebrew]																																																												
16	WCP1252 Latin I																																																												
17	WCP1253 [Greek]																																																												
18	CP852 [Latina 2]																																																												
19	CP858 Multilingual Latin I +Euro)																																																												
20	Iran II																																																												
21	Latvian																																																												
22	CP864 [Arabic]																																																												
23	ISO-8859-1 [West Europe]																																																												
24	CP737 [Greek]																																																												
25	WCP1257 [Baltic]																																																												
26	Thai																																																												
27	CP720[Arabic]																																																												
28	CP855																																																												

	29 CP857[Turkish] 30 WCP1250[Central Europe] 31 CP775 32 WCP1254[Turkish] 33 WCP1255[Hebrew] 34 WCP1256[Arabic] 35 WCP1258[Vietnam] 36 ISO-8859-2[Latin 2] 37 ISO-8859-3[Latin 3] 38 ISO-8859-4[Baltic] 39 ISO-8859-5[Cyrillic] 40 ISO-8859-6[Arabic] 41 ISO-8859-7[Greek] 42 ISO-8859-8[Hebrew] 43 ISO-8859-9[Turkish] 44 ISO-8859-15 [Latin 9] 45 Thai2 46 CP856 47 Cp874 252 CP932 SHIFT_JIS 253 UNICODE UCS-2 254 BIG5 255 GBK
Range	$0 \leq n \leq 255$
Default	0
Notes	None
Example	1B 40 1C 2E 1B 74 00 80 81 82 83 84 85 86 87 88 89 8A 8B 8C 8D 8E 8F 90 91 92 93 94 95 96 97 98 9A 9B 9C 9D 9E 9F A0 A1 A2 A3 A4 A5 A6 A7 A8 A9 AA AB AC AD AE AF B0 B1 B2 B3 B4 B5 B6 B7 B8 B9 BA BB BC BD BE BF C0 C1 C2 C3 C4 C5 C6 C7 C8 C9 CA CB CC CD CE CF D0 D1 D2 D3 D4 D5 D6 D7 D8 D9 DA DB DC DD DE DF E0 E1 E2 E3 E4 E5 E6 E7 E8 E9 EA EB EC ED EE EF F0 F1 F2 F3 F4 F5 F6 F7 F8 F9 FA FB FC FD FE FF 0D 0A

③Graphic printing command

Fill Graphics vertical module data

Name	Fill Graphics vertical module data
Code	ASCII : ESC * m Hl Hh [d]k DEC : 27 42 m Hl Hh [d]k HEX : 1B 2A m Hl Hh [d]k
Function	Print vertical module graphic data,the parameters are as below:

	<p>m is bit map format: m mode horizontal scale vertical scale 0 8dots single density×2 ×3 1 8dots double density ×1 ×3 32 24dots single density ×2 ×1 33 24dots double density ×1 ×1 Hl、Hh is horizontal direction dots(Hl+256×Hh) [d]k is bit map data K used for indicating bit map data bytes,not for transfer.</p>
<p>Parameter range</p>	<p>XX58: m = 0、1、32、33 $1 \leq Hl + Hh \times 256 \leq 384$ $0 \leq d \leq 255$ k = Hl + Hh × 256 (when m = 0、1) k = (Hl + Hh × 256) × 3 (when m = 32、33) XX80: m = 0、1、32、33 $1 \leq Hl + Hh \times 256 \leq 576$ $0 \leq d \leq 255$ k = Hl + Hh × 256 (when m = 0、1) k = (Hl + Hh × 256) × 3 (when m = 32、33)</p>
<p>Default</p>	<p>None</p>
<p>Notes</p>	<p>[d]k corresponding bit is 1,which means that this bit can print. While it is 0,it means that this bit can not print. The part of graphics horizontal direction which exceeds the printing area will be ignored. The relations between Bit map data and printing effects is as below:</p> <div style="text-align: center;"> <p>The diagram illustrates the mapping of bit map data to printing effects. On the left, labeled '8 dot', a horizontal row of three data bytes (d1, d2, d3) is shown. Dashed lines connect these bytes to a vertical stack of eight bits, with the top bit labeled 'high' and the bottom bit labeled 'low'. On the right, labeled '24 dot', a 3x3 grid of data bytes (d1-d9) is shown. Dashed lines connect this grid to a vertical stack of twenty-four bits, with the top bit labeled 'high' and the bottom bit labeled 'low'.</p> </div> <p>The command fills only the printing buffer, graphics printing can start only after receiving the printing commands.Printing buffer will be cleared after graphic printing. If you need to print higher graphics,you can divide it into several sections which has 8 (m = 0、1) or 24 (m = 32、33) dots graphics to print. After filling graphic data,you can continue to fill other information to make</p>

	<p>graphic and other information print simultaneously.</p> <p>After filling bitmap,you can use ESC J(n=24) command to print, and also can use LF command to print.But using LF command will cause paper feeding(feeding paper according to the line space),and make graphic continuous between different lines.And can set line space as 0 to avoid feeding too much.(Dot matrix printer may drift when it starts,pls send data continuously if occurs line broken.</p>
Example	<pre>1B 40 1b 2a 00 0C 00 FF FF FF FF FF FF FF FF FF FF FF FF 1B 33 00 0A</pre>

Print Graphics horizontal module data

Name	Print Graphics horizontal module data																				
Code	ASCII : GS v 0 DEC : 29 118 48 m xL xH yL yH [d]k HEX : 1D 76 30 m xL xH yL yH [d]k																				
Function	<p>Print horizontal module graphic data,the parameters are as below: m as bitmap method:</p> <table border="1"> <thead> <tr> <th>m</th> <th>Model</th> <th>Horizontal scale</th> <th>Vertical scale</th> </tr> </thead> <tbody> <tr> <td>0,48</td> <td>Normal</td> <td>× 1</td> <td>× 1</td> </tr> <tr> <td>1,49</td> <td>Double-width</td> <td>× 2</td> <td>× 1</td> </tr> <tr> <td>2,50</td> <td>Double-height</td> <td>× 1</td> <td>× 2</td> </tr> <tr> <td>3,51</td> <td>Quadruple</td> <td>× 2</td> <td>× 2</td> </tr> </tbody> </table> <p>xL、xH were selected as the data bytes (xL+xH×256) in the horizontal direction for the bitmap. yL, yH were selected as the data bytes (yL+yH×256) in the vertical direction for the bitmap. [d]k for bitmap data k for bitmap data bytes, k used for indicating, not for transfer.</p>	m	Model	Horizontal scale	Vertical scale	0,48	Normal	× 1	× 1	1,49	Double-width	× 2	× 1	2,50	Double-height	× 1	× 2	3,51	Quadruple	× 2	× 2
m	Model	Horizontal scale	Vertical scale																		
0,48	Normal	× 1	× 1																		
1,49	Double-width	× 2	× 1																		
2,50	Double-height	× 1	× 2																		
3,51	Quadruple	× 2	× 2																		
Parameter range	XX58: $0 \leq m \leq 3; 48 \leq m \leq 51$ $1 \leq xL + xH \times 256 \leq 48$ $0 \leq yL \leq 255, 0 \leq yH \leq 255$ $0 \leq d \leq 255$ $k = (Hl + Hh \times 256) \times (yL + yH \times 256)$ XX80: $0 \leq m \leq 3; 48 \leq m \leq 51$ $1 \leq xL + xH \times 256 \leq 72$ $0 \leq yL \leq 255, 0 \leq yH \leq 255$ $0 \leq d \leq 255$ $k = (Hl + Hh \times 256) \times (yL + yH \times 256)$																				
Default	None																				
Notes	[d] k corresponding bit is 1,which means that this bit can print. While it is 0,it																				

	<p>means that this bit can not print.</p> <p>If the horizontal bytes exceed printing area, then the exceeding part will be ignored.</p> <p>The paper feeds accordingly to the image size when this commanding is using, not influenced by the setting of ESC 2, ESC 3 line space.</p> <p>After this command, the printing coordinates will be reset to the left margin and the image content will be cleared.</p> <p>the relationship between bitmap data and the printing effect is as below:</p> <table border="1" style="margin: 10px auto;"> <tr> <td>d1</td> <td>d2</td> <td>.....</td> <td>dx</td> </tr> <tr> <td>d(x+1)</td> <td>d(x+2)</td> <td>.....</td> <td>d(x+2)</td> </tr> <tr> <td> </td> <td> </td> <td>.....</td> <td> </td> </tr> <tr> <td>.....</td> <td>d(k-2)</td> <td>d(k-1)</td> <td>dk</td> </tr> </table> <p style="text-align: center;">MSB LSB MSB LSB MSB LSB MSB LSB</p> <p>This command has the printing function, data will be transferred while printing, no need to use the printing command again</p>	d1	d2	dx	d(x+1)	d(x+2)	d(x+2)			d(k-2)	d(k-1)	dk
d1	d2	dx														
d(x+1)	d(x+2)	d(x+2)														
																
.....	d(k-2)	d(k-1)	dk														
Example	<p>1B 40</p> <p>1d 76 30 00 03 00 09 00</p> <p>FF FF</p> <p>FF FF FF</p>																

Define downloaded bitmap

Name	Define downloaded bitmap
Code	<p>ASCII : GS * x y d1...d(x*y*8)</p> <p>DEC : 29 42 x y d1 ...d(x*y*8)</p> <p>HEX : 1D 2A x y d1...d(x*y*8)</p>
Function	<p>using x and y to appoint dots to define the downloaded bitmap</p> <p>x appoints that the horizontal dots as 8*x.</p> <p>y appoints that the vertical dots as 8*y.</p>
Parameter range	<p>1 ≤ x ≤ 255</p> <p>1 ≤ y ≤ 48</p> <p>x*y ≤ 1536</p> <p>0 ≤ d ≤ 255</p>
Default	None
Notes	<p>If x*y is out of the specified range, this command will be forbidden.</p> <p>The d indicates bitmap data. Data (d) specifies the printing bit as 1 and the not printing bit as 0.</p> <p>The downloaded bitmap definition will be cleared when:</p> <p>ESC @ is executed.</p> <p>ESC & is executed.</p> <p>Printer is reset or the power is turned off.</p> <p>The following figure shows the relationship between the downloaded</p>

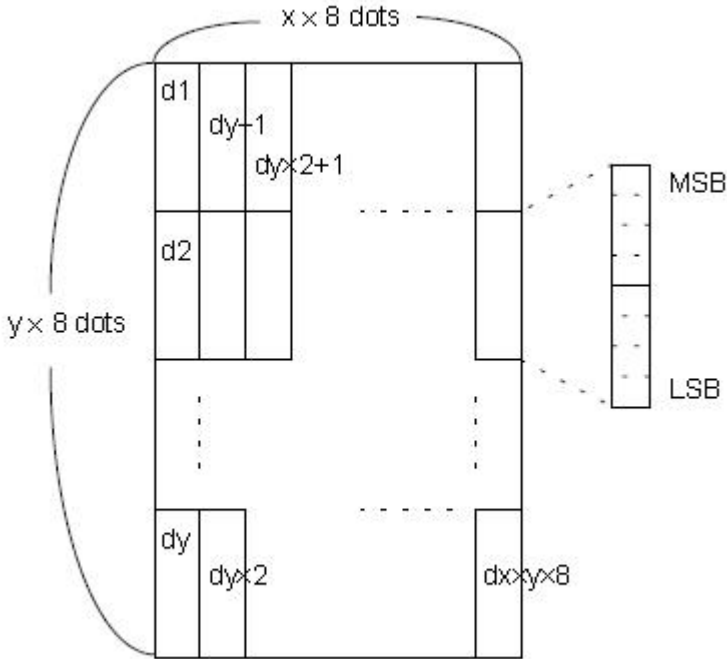
	<p>bitmap and the printed data</p> 
<p>Example</p>	<pre> 1B 40 1D 2A 03 03 FF 1D 2F 00 </pre>

Print downloaded bitmap

<p>Name</p>	<p>Print downloaded bitmap</p>										
<p>Code</p>	<p>ASCII : GS / m DEC : 29 47 m HEX : 1D 2F m</p>										
<p>Function</p>	<p>Prints a downloaded bitmap using the mode specified by m. Using the mode that m appointed to print downloaded bitmap</p> <table border="1" data-bbox="405 1592 804 1816"> <thead> <tr> <th>m</th> <th>Model</th> </tr> </thead> <tbody> <tr> <td>0, 48</td> <td>Normal</td> </tr> <tr> <td>1, 49</td> <td>Double-width</td> </tr> <tr> <td>2, 50</td> <td>Double-height</td> </tr> <tr> <td>3, 51</td> <td>Quadruple</td> </tr> </tbody> </table>	m	Model	0, 48	Normal	1, 49	Double-width	2, 50	Double-height	3, 51	Quadruple
m	Model										
0, 48	Normal										
1, 49	Double-width										
2, 50	Double-height										
3, 51	Quadruple										
<p>Parameter range</p>	<p>0 ≤ m ≤ 3 48 ≤ m ≤ 51</p>										
<p>Default</p>	<p>None</p>										

Notes	<p>this command will be ignored if the bitmap data has not been defined.</p> <p>In standard mode, this command is effective only when there is no data in the buffer area.</p> <p>This command has no effect in the print modes (emphasized, double-strike, downloadedline, character size, or white/black reverse printing), except for upsidedown printing mode.</p> <p>If the downloaded bitmap which will be printed exceeds the printing area, then the excess data will not be printed.</p>
Example	No

Define NV bitmap

Name	Define NV bitmap
Code	ASCII : FS q n [xL xH yL yH d1...dk]1...[xL xH yL yH d1...dk]n DEC : 28 113 n [xL xH yL yH d1...dk]1...[xL xH yL yH d1...dk]n HEX : 1C 71 n [xL xH yL yH d1...dk]1...[xL xH yL yH d1...dk]n
Function	<p>Define the NV bitmap using the specified n.</p> <p>n specifies the number of the defined NV bitmap.</p> <p>xL, xH means that the defined NV bitmap specifies the horizontal dots as $(xL+xH*256)*8$</p> <p>yL, yH means that the defined NV bitmap specifies the vertical dots as $(yL + yHx256)*8$</p>
Parameter range	$1 \leq n \leq 255$ $0 \leq xL \leq 255$ $0 \leq xH \leq 3$ $(1 \leq (xL+xH*256) \leq 1023)$ $0 \leq yL \leq 255$ $0 \leq yH \leq 1$ $(1 \leq (yL+yH*256) \leq 288)$ $0 \leq d \leq 255$ $k = (xL+xH*256)*(yL+yH*256)*8$ Totaled the defined data Area = 64 k bytes
Default	None
Support Model	All
Notes	<p>Frequent writing command executions may damage the NV memory. Therefore, it is recommended to write the NV memory no more than 10 times per day.</p> <p>The printer performs a hardware reset operation after the procedure of placing the image into the NV memory. Therefore, user-defined characters, downloaded bitmaps should be defined only after completing this command. The printer clears the receiving and printing buffers and resets the printer to the mode that workable when power on. (hardware reset interface is not supported)</p> <p>This command cancels all NV bitmaps that have already been defined by this</p>

command.

From the beginning of the processing of this command till the accomplishment of hardware reset, mechanical operations (including initializing the position of the print head when the cover is open, paper feeding using the FEED button, etc.) cannot be performed.

During this command processing, the printer is busy and stops receiving data when writing data to the user's NV memory. Therefore, data transmission, including real-time commands, is prohibited during the execution of this command.

NV bitmap is a bitmap defined in non-volatile memory, Define FS p printing with FS q.

In standard mode, this command is valid only when processed at the beginning of the line.

This command is valid when 7 bytes <FS yH> of the command are processed normally.

When the data volume exceeds the left capacity of the range defined by xL, xH, yL, and yH, the printer will process the range defined by xL, xH, yL, and yH outside the defined range.

In the first group of NV bitmaps, when any one of xL, xH, yL, yH is out of the definition range, this command is disabled.

In groups of NV bitmaps other than the first group, when xL, xH, yL, yH out of the defined range, it stops processing this command and starts writing into the NV images. At this time, NV bitmaps that haven't been defined are disabled (undefined), but any NV bitmaps before that are enabled.

The d indicates the definition data. In data (d) a 1 bit specifies a dot to be printed and a 0 bit specifies a dot not to be printed.

This command defines n as the number of a NV bitmap. Numbers rise in order from NV bitmap 01H. Therefore, the first data group [xL xH yL yH d1...dk] is NV bitmap 01H, and the last data group [xL xH yL yH d1...dk] is NV bitmap n. The total agrees with the number of NV bitmaps specified by the command FS p.

The definition data for an NV bitmap consists of [xL xH yL yH d1...dk]. Therefore, when only one NV bitmap is defined n=1, the printer processes a data group [xL xH yL yH d1...dk] once. The printer uses ([data: (xL xH× 256)×(yL yH× 256)×8] [header :4]) bytes of NV memory.

The definition area in this printer is a maximum of 192K bytes. This command can define several NV bitmaps, but cannot define bitmap data whose total capacity [bitmap data header] exceeds 192K bytes.

The printer does not transmit ASB status or perform status detection during processing of this command even when ASB is specified.

Once an NV bitmap is defined, it is not erased by performing ESC @, reset,

and power off.

This command performs only definition of an NV bitmap and does not perform printing. Printing of the NV bitmap is performed by the FS pcommand.

Diagram: when $xL = 64, xH = 0, yL = 96, yH = 0$

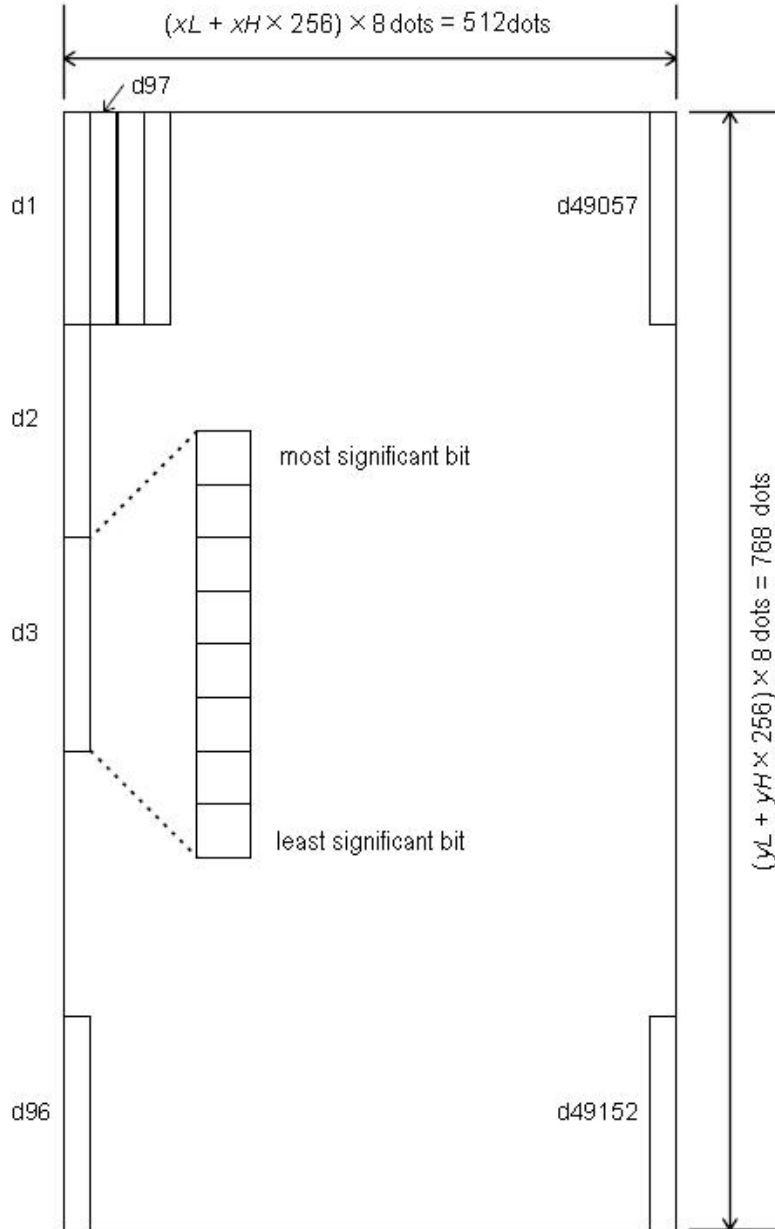

Example	<pre> 1B 40 1C 71 01 03 00 03 00 FF 1C 70 01 00 </pre>
---------	---

Print NV bitmap

Name	Print NV bitmap
------	-----------------

Code	ASCII : FS p n m DEC : 28 112 n m HEX : 1C 70 n m										
Function	Print NV bitmap n using the mode specified by m. <table border="1" data-bbox="405 387 770 611"> <thead> <tr> <th>m</th> <th>Mode</th> </tr> </thead> <tbody> <tr> <td>0, 48</td> <td>Normal</td> </tr> <tr> <td>1, 49</td> <td>Double-width</td> </tr> <tr> <td>2, 50</td> <td>Double-height</td> </tr> <tr> <td>3, 51</td> <td>Quadruple</td> </tr> </tbody> </table>	m	Mode	0, 48	Normal	1, 49	Double-width	2, 50	Double-height	3, 51	Quadruple
m	Mode										
0, 48	Normal										
1, 49	Double-width										
2, 50	Double-height										
3, 51	Quadruple										
Parameter range	$0 \leq m \leq 3$ $48 \leq m \leq 51$ $1 \leq n \leq 255$										
Default	None										
Support	All										
Notes	<p>n is the number of the NV bitmap (defined using the FS q command). m specifies the bitmap mode. NV bitmap is a bitmap defined in non-volatile memory by FS q and printed by FS p. This command is not effective when the specified NV bitmap has not been defined.</p> <p>In standard mode, this command is effective only when there is no data in the print buffer.</p> <p>This command is not affected by print modes (Bold printing, overlapping, underline, character size, white/black reverse printing, or 90° rotated characters, etc.), except upside-down printing mode.</p> <p>If the downloaded bit-image to be printed exceeds one line, the excess data is not printed.</p> <p>This command feeds dots (for the height n of the NV bitmap) in normal and double-width modes, and (for the height n - 2 of the NV bitmap) in double height and quadruple modes, regardless of the line space specified by ESC 2 or ESC 3.</p> <p>After printing the bitmap, this command sets the print position to the beginning of the line and processes the data that follows as normal data.</p>										
Example	None										

④ Tab Commands

Horizontal tab

Name	Horizontal tab
Code	ASCII : HT DEC : 9

	HEX : 09
FUNCTION	Move the print position to the next tab position
Parameter range	None
Defaults	None
Notes	Tab position set by ESC D If the tab position is not set(the default is no horizontal position),this command will be treated as an LF command If the tab position exceeds the print area,the coordinates will move to the star position of the next line(as the data is full,print and wrap)
Example	none

Horizontal tab position setting

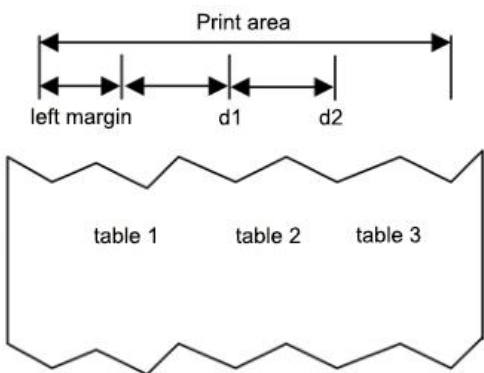
Name	horizontal tab position setting
Code	ASCII : ESC D [d]k NUL DEC : 27 68 [d]k 0 HEX : 1B 44 [d]k 00
Function	Set horizontal tab position, parameter meaning as below: d1 ... dk: horizontal position,in 8 as unit,null as the terminator
Parameter range	XX58: $1 \leq d \leq 46$ ($d_1 < d_2 < \dots < d_k$, $1 \leq k \leq 16$) XX80: $1 \leq d \leq 70$ ($d_1 < d_2 < \dots < d_k$, $1 \leq k \leq 16$)
Defaults	The default positioning position is the 8-character interval(Column 9 17 25...) of the font A(12-24)
Support model	All
Notes	<p>Tab position as below:</p>  <p>Maximum support for the setting of 16 tab position Using this command,the setting of previous tab position will be canceled k is for indication purpose,no transmission When transport [d]k,and come across NULL,should be considered over If dk less than or equal to dk-1,should be considered over,and balance data is treated as normal data processing TAB position could be changed by HT command When the left margin changes, the TAB position changes simultaneously The command setting will be valid after ESC @、 printer reset、 power off</p>

Example	1B 44 04 06 08 0A 00 09 30 09 31 09 32 09 33 0D 0A
---------	--

⑤ One-dimension bar code command

1D bar code readable character(HRI) print position setting

Name	1D bar code readable character(HRI)print position setting
Code	ASCII : GS H n DEC : 29 72 n HEX : 1D 48 n
Function	Set 1D bar code readable character(HRI)print position,n parameter meaning as below: n print position 0, 48 don't print 1, 49 above the bar code 2, 50 below the bar code 3, 51 above and below the bar code
Parameter range	$0 \leq n \leq 3$ or $48 \leq n \leq 51$
Defaults	n = 0
Notes	The command setting will be valid after ESC @、printer reset、power off
Example	None

1D bar code height setting

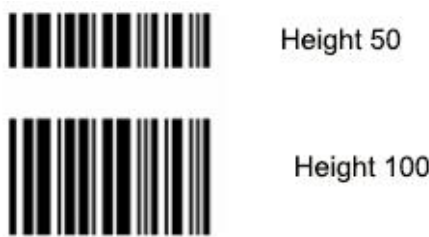
Name	1D bar code height setting
Code	ASCII : GS h n DEC : 29 104 n DEX : 1D 68 n
Function	Parameter n specifies the height of a bar code in dots: 
Parameter range	$1 \leq n \leq 255$
Defaults	n = 64
Notes	The command setting will be valid after ESC @、printer reset、power off
Example	None

1D bar code width setting

Name	1D bar code width setting
Code	ASCII : GS w n DEC : 29 119 n

	HEX : 1D 77 n
Function	<p>Parameter n specifies the unit of a bar code in dots:</p> 
Parameter range	$1 \leq n \leq 6$
Defaults	$n = 2$
Noted	The command setting will be valid after ESC @、printer reset、power off
Example	None

1D bar code printing

Name	1D bar code printing																																							
Code	<p>(A) ASCII : GS k m [d]k NUL DEC : 29 107 m [d]k NUL Hex : 1D 6B m [d]k NUL</p> <p>(B) ASCII : GS k m n [d]k DEC : 29 107 m n [d]k Hex : 1D 6B m n [d]k</p>																																							
Function	<p>1D bar code printing,the parameters meaning as below: m is encoding n is code data length,only for (command B),the difference between (A) and (B)is that the data (A) end with NULL,but (B) indicates the data length [d]k is bar code data K is the length of the bar code data,for sign,no transmission Parameters relationship as below: (Command A)</p> <table border="1"> <thead> <tr> <th rowspan="2">m</th> <th rowspan="2">Coding system</th> <th colspan="4">Bar code length (SP show space)</th> </tr> <tr> <th>Data length</th> <th>k</th> <th>Character set</th> <th>Data (d)</th> </tr> </thead> <tbody> <tr> <td>0</td> <td>UPC-A</td> <td>fixed</td> <td>k = 11, 12</td> <td>0~9</td> <td>$48 \leq d \leq 57$</td> </tr> <tr> <td>1</td> <td>UPC-E</td> <td>fixed</td> <td>$6 \leq k \leq 8,$ k = 11, 12</td> <td>0~9</td> <td>$48 \leq d \leq 57$ [when k = 7,8,11,12, d1 = 48]</td> </tr> <tr> <td>2</td> <td>JAN13 (EAN13)</td> <td>fixed</td> <td>k = 12, 13</td> <td>0~9</td> <td>$48 \leq d \leq 57$</td> </tr> <tr> <td>3</td> <td>JAN8</td> <td>fixed</td> <td>k = 7, 8</td> <td>0~9</td> <td>$48 \leq d \leq 57$</td> </tr> </tbody> </table>						m	Coding system	Bar code length (SP show space)				Data length	k	Character set	Data (d)	0	UPC-A	fixed	k = 11, 12	0~9	$48 \leq d \leq 57$	1	UPC-E	fixed	$6 \leq k \leq 8,$ k = 11, 12	0~9	$48 \leq d \leq 57$ [when k = 7,8,11,12, d1 = 48]	2	JAN13 (EAN13)	fixed	k = 12, 13	0~9	$48 \leq d \leq 57$	3	JAN8	fixed	k = 7, 8	0~9	$48 \leq d \leq 57$
m	Coding system	Bar code length (SP show space)																																						
		Data length	k	Character set	Data (d)																																			
0	UPC-A	fixed	k = 11, 12	0~9	$48 \leq d \leq 57$																																			
1	UPC-E	fixed	$6 \leq k \leq 8,$ k = 11, 12	0~9	$48 \leq d \leq 57$ [when k = 7,8,11,12, d1 = 48]																																			
2	JAN13 (EAN13)	fixed	k = 12, 13	0~9	$48 \leq d \leq 57$																																			
3	JAN8	fixed	k = 7, 8	0~9	$48 \leq d \leq 57$																																			

	(EAN8)				
4	CODE39	changeable	$1 \leq k$	0~9, A~Z SP, \$, %, *, +, -, ., /	$48 \leq d \leq 57$, $65 \leq d \leq 90$, $d = 32, 36, 37,$ $42, 43, 45, 46,$ 47
5	ITF (Interleaved 2 of 5)	changeable	$2 \leq k \leq 255$ (even numbers)	0~9	$48 \leq d \leq 57$
6	CODABAR (NW-7)	changeable	$1 \leq k$	0~9, A~D, a~d \$, +, -, ., /, :	$48 \leq d \leq 57$, $65 \leq d \leq 68$, $97 \leq d \leq 100$, $d = 36, 43, 45,$ $46, 47, 58$ $(65 \leq d1 \leq 68,$ $65 \leq dk \leq 68,$ $97 \leq d1 \leq 100,$ $97 \leq dk \leq 100)$

(Command B)

m	Coding system	Bar code length (SP show space)			
		Data length	n	Character set	Data (d)
65	UPC-A	fixed	$n = 11, 12$	0~9	$48 \leq d \leq 57$
66	UPC-E	fixed	$6 \leq n \leq 8,$ $n = 11, 12$	0~9	$48 \leq d \leq 57$ [when $n =$ $7, 8, 11, 12,$ $d1 = 48$]
67	JAN13 (EAN13)	fixed	$n = 12, 13$	0~9	$48 \leq d \leq 57$
68	JAN8 (EAN8)	fixed	$n = 7, 8$	0~9	$48 \leq d \leq 57$
69	CODE39	changeable	$1 \leq n$	0~9, A~Z SP, \$, %, *, +, -, ., /	$48 \leq d \leq 57$, $65 \leq d \leq 90$, $d = 32, 36, 37,$ $42, 43, 45, 46,$ 47
70	ITF (Interleaved 2 of 5)	changeable	$2 \leq n \leq 255$ (even numbers)	0~9	$48 \leq d \leq 57$
71	CODAB	chan	$1 \leq n$	0~9, A~D, a~d	$48 \leq d \leq 57$,

		AR (NW-7)	geable		\$, +, -, ., /, :	65≤d≤68, 97≤d≤100, d = 36, 43, 45, 46, 47, 58 (65≤d1≤68, 65≤dk≤68, 97≤d1≤100, 97≤dk≤100)
	72	CODE93	channelgeable	1≤n≤255	00H~7FH	0≤d≤127
	73	CODE128	channelgeable	1≤n≤255	00H~7FH C1H~C4H(FNC)	0≤d≤127 d = 193, 194,195,196
	74	UCC/EAN128	channelgeable	1≤n≤255	00H~7FH C1H~C4H(FNC)	0≤d≤127 d = 193, 194,195,196
Parameter range	(A) 0 ≤ m ≤ 6 (B) 65 ≤ m ≤ 74					
Defaults	None					
Notes	<p>If the bar code width exceed the printable area,the printer does not perform barcode printing</p> <p>Paper feed as needed when the command is carried out,that not affected by ESC2,ESC3 line space settings,and do not influence line space settings The command is not affected by ESC ! character style setting</p> <p>The print position is resorted to the print start location after the command is executed</p> <p>m parameter 0 ~ 6(A) and 65 ~ 71(B) select the same coding system,the same printing effect</p> <p>m parameter is 0 ~ 6(A),barcode data end with NULL</p> <p>m parameter is 65 ~ 74(B),barcode data n stand for data length</p> <p>K is for sign,no transmission</p> <p>When print UPCA (m = 0 or 65) ,Please pay attention for the following points: Whatever the input data length is 11 or 12,the check bit is automatically inserted or corrected Initial character,central split character,and terminator are inserted automatically</p> <p>When print UPCE (m = 1 or 66) ,Please pay attention as following: The system character (NSC) 0 will be inserted automatically when data length is 6 The first system character (NSC) d1 must be 0 when the data length is 7,8,11 and 12. Whatever the data length is 6,7,8,11 and 12,the check bit inserted or corrected automatically</p>					

Whatever the input data length is 6,7,8,11,and 12,the barcode readable character(HRI) just show 6 as data,but excluded system character (NSC) and check code;

The transition relation between transmission and printing data as below:

Transmitted data										Printed data					
d2	d3	d4	d5	d6	d7	d8	d9	d10	d11	d1	d2	d3	d4	d5	d6
0~9	0~9	0	0	0	-	-	0~9	0~9	0~9	d2	d3	d9	d10	d11	0
0~9	0~9	1	0	0	-	-	0~9	0~9	0~9	d2	d3	d9	d10	d11	1
0~9	0~9	2	0	0	-	-	0~9	0~9	0~9	d2	d3	d9	d10	d11	2
0~9	0~9	3~9	0	0	-	-	-	0~9	0~9	d2	d3	d4	d10	d11	3
0~9	0~9	0~9	1~9	0	-	-	-	-	0~9	d2	d3	d4	d5	d11	4
0~9	0~9	0~9	0~9	1~9	-	-	-	-	5~9	d2	d3	d4	d5	d6	d11

When d6 is 1~9,be sure d7,d8,d9,d10 are 0,and d11 is 5~9

Initial character,terminator automatically inserted

When print EAN13(m = 2 or 67),Please pay attention as following:

Whatever the input data length is 12 or 13,check bit is automatically inserted or corrected

Initial character,central split character and terminator inserted automatically

When print EAN8(m = 3 or 68),please pay attention as following:

Whatever input data length is 7 or 8,the check bit is automatically inserted or corrected

Initial character,central split character and terminator inserted automatically

When print CODE39(m = 4 or 69),please pay attention as following:

When d1 or dn are not Initial character/terminator "*" , encoder is automatically inserted "*"

When middle of the data encounter "*" , the encoder regard it as terminator, the other data as the normal data;

The check bit could not calculate and add automatically

When print ITF25(m = 5 or 70), please pay attention as following:

Initial character and terminator inserted automatically

The check bit could not calculate and add automatically

When print CODABAR (NW-7) (m = 6 or 71),please pay attention as following:

Initial character and terminator could not inserted automatically,but manual addition by user, that the range from "A"~"D" or "a"~"d"

Check bit could not calculate and add automatically

When print CODE93(m = 72),please pay attention as following:

Initial character and terminator inserted automatically

The two check code are automatically calculated and then inserted

When barcode readable character(HRI) is set to print, there is no HRI character which indicating start/end

When barcode readable character(HRI) is set to print,the control character will be replaced with space

When print CODE128(m = 73),please pay attention as following:

The encoding system intelligently identifies data and implements minimum length encoding without the user set character (include starting character set) or switch character

Function character FNC1~FNC4 use C1H~C4H and input it

The check bit could calculate and add automatically

When barcode readable character(HRI) is set to print,the control character and FNC1~FNC4 will be replaced with space

When print EAN128(m = 74),please pay attention as following:

Basic construction as below:

Initial character set	FNC1	AI	Data part	Check bit A	Check bit B	Terminator
Inserted automatically		(d1...dk)			Inserted automatically	

Connection structure as below:

Initial character set	FNC 1	AI	Data part	Check bit A	FNC 1	AI	Data part	Check bit A	Check bit B	Terminator
Inserted automatically		(d1...dk)						Inserted automatically		

The encoding system intelligently identifies data and implements minimum length encoding without the user set character (include starting character set) or switch character

Function character FNC1~FNC4 use C1H~C4H and input it

User input data AI,which do not need “(“”)” for indication,encoding system inserted automatically,otherwise it will be wrong.For example,GS k 74 18 "019501234567890*", 01 is AI,the following will be wrong:GS k 74 18 "(01)9501234567890*"

When user use the connection structure,need to insert FNC1(C1H”Decimal=193”) in the middle.The input example as following:

GS k 74 18 "019501234567890*" 193 "029501234567890*"

When barcode readable character(HRI) is set to print,the control character will be replaced with space,then cancel FNC1~FNC4

Example
1b 40 1d 48 02
1d 6b 41 0c 31 32 33 34 35 36 37 38 39 30 31 32

	1d 6b 42 0c 30 32 33 34 35 36 30 30 30 30 38 39 1d 6b 43 0c 30 32 33 34 35 36 30 30 30 30 38 39 1d 6b 44 08 30 32 33 34 35 36 30 30 1d 6b 45 08 30 32 33 34 35 36 30 30 1d 6b 46 08 30 32 33 34 35 36 30 30 1d 6b 47 08 41 32 33 34 35 36 30 41 1d 6b 48 08 41 30 32 33 34 35 36 41 1d 6b 49 08 41 30 32 33 34 35 36 41
--	--

⑥ Status querying Commands

Transmission status

Name	Transmission status													
Code	ASCII : GS r n DEC : 29 114 n HEX : 1D 72 n													
Function	Transmits the status specified by n as follows: <table border="1" style="width: 100%; margin-top: 5px;"> <thead> <tr> <th style="width: 15%;">n</th> <th style="width: 85%;">Function</th> </tr> </thead> <tbody> <tr> <td>1, 49</td> <td>Transmits paper sensor status</td> </tr> </tbody> </table>				n	Function	1, 49	Transmits paper sensor status						
n	Function													
1, 49	Transmits paper sensor status													
Range	n = 1, 49													
Default	None													
Notes	<p>When using a serial interface</p> <p>When DTR/DSR control is selected, the printer transmits only 1 byte after confirming the host is ready to receive data (DSR signal is SPACE). If the host computer is not ready to receive data (DSR signal is MARK), the printer will wait until the host is ready.</p> <p>When XON/XOFF control is selected, the printer transmits only 1 byte without confirming the status of the DSR signal.</p> <p>This command is executed when data is generated in the print buffer. Therefore, there may be a time interval between receiving the command and sending status, depending on the status of the receiving buffer.</p> <p>When Auto Status Back (ASB) is enabled using GS a, the status transmitted by GS r and the ASB status must be differentiated using.</p> <p>The status types to be transmitted are shown as below:</p> <table border="1" style="width: 100%; margin-top: 10px;"> <thead> <tr> <th style="width: 10%;">Bit</th> <th style="width: 10%;">Off/On</th> <th style="width: 10%;">Hex</th> <th style="width: 10%;">Decimal</th> <th style="width: 60%;">Status for ASB</th> </tr> </thead> <tbody> <tr> <td>0,1</td> <td>-</td> <td>-</td> <td>-</td> <td>Undefined.</td> </tr> </tbody> </table>				Bit	Off/On	Hex	Decimal	Status for ASB	0,1	-	-	-	Undefined.
Bit	Off/On	Hex	Decimal	Status for ASB										
0,1	-	-	-	Undefined.										

	2,3	Off	00	0	Paperend sensor: paper adequate.
		On	(0C)	(12)	Paperend sensor: paper near end.
	4	Off	00	0	unused. fixed to be Off.
	5,6	-	-	-	Undefined.
	7	Off	00	0	unused. fixed to be Off.
	Paper sensor status (n = 1, 49): Bits 2 and 3: When the paper end sensor detects the paper end, the printer goes offline and does not execute this command. Therefore, bits 2 and 3 do not transmit the status of paper end.				
Example	None				

Real-time transmission status

Name	Real-time transmission status
Code	ASCII : DLE EOT n DEC : 16 4 n HEX : 10 04 n
Function	According to below parameters, transit the real-time status of printer, n stands for printer status: N=1:transmit printer status N=2:transmit off-line status N=3:transmit error status N=4:transmit paper sensor status
Range	$1 \leq n \leq 4$
Default	None
Support	All

Notes

•Printer return to the relative status immediately after receiving the command

• this command try not to put in command list between 2 or more bite .
Though printer being forbid by ESC=,this command still effective.
Printer transmit current situation ,each situation show by 1 bite data.
It is not sure host computer will receive printer transmit situation.
Printer executed immediately after received the command.
The command only effective for serial printer.Printer start to work immediately after receiving this command at any situation.

n=1: printer status

Bit	0/ 1	Hexadecim al	decimalis m	Function
0	0	00	0	Fixed to be 0
1	1	02	2	Fixed to be 1
2	0	00	0	Two drawers kick(no drawer, fixed to be 0)
	1	04	4	Turn off two cashbox
3	0	00	0	On-line
	1	08	8	Off-line
4	1	10	16	Fixed to be 1
5, 6		--	--	undefined
7	0	00	00	The paper has been torn away
	1	80	96	The paper hasn't been torn away

n=2: transit off-line status

bite	0 / 1	Hexadecim al	decimalism	Function
0	0	00	0	Fixed to be 0
1	1	02	2	Fixed to be 1
2	0	00	0	Turn off upper cover

	1	04	4	Open upper cover
3	0	00	0	Not press feed key
	1	08	8	press feed key
4	1	10	16	Fixed to be 1
5	0	00	0	Paper adequate
	1	20	32	Paper shortage
6	0	00	00	No error
	1	40	64	Error
7	0	00	0	Fixed to be 0

n=3: transmit error status

bite	0	Hexadecim	decimalis	Function
	/	al	m	
	1			
0	0	00	0	Fixed to be 0
1	1	02	2	Fixed to be 1
2		--	--	Undefined
3	0	00	0	No cutter error
	1	08	8	Cutter error
4	1	10	16	Fixed to be 1
5	0	00	0	No unrecoverable error
	1	20	32	Unrecoverable error
6	0	00	00	Printer head temp and voltage are normal
	1	40	64	Printer head temp. and voltage are exceed
7	0	00	0	Fixed to be 0

Unrecoverable error: abnormal input voltage

Automatic recovery error: refers to the printing head overheating error.

When the printing head overheating error occurs, wait for a period of time.

When the printing head temperature drops, the error will be automatically recovered.

	n=4: paper sensor status				
	bite	0 / 1	Hexadecimal	decimalism	Function
	0	0	00	0	Fixed to be 0
	1	1	02	2	Fixed to be 1
	2, 3	0	00	0	Paper
		1	0C	12	Paper near-end
	4	1	10	16	Fixed to be 1
	5, 6	0	00	0	Paper
		1	60	96	Paper end
7	0	00	0	Fixed to be 0	
Example	10 04 01 10 04 02 10 04 03 10 04 04				

⑦ Two-dimensional bar code commands

Mode type of QR code

Name	Mode type of QR bar code
Code	ASCII : GS (k pL pH cn fn n Decimal : 29 40 107 pL pH cn fn n Hexadecimal : 1D 28 6b pL pH cn fn n
Function	Setting mode type of QR bar code to [n dot × n dot].
Parameter range	pL=3, pH=0 cn=49 fn=67 0 ≤ n ≤ 16
Default	n=3

Notes	Setting mode type of QR code to [n dot × n dot].
Example	None
Name	Mode type of QR bar code

Setting error correction level of QR code

Name	Setting error correction level of QR code																
Code	ASCII : GS (k pL pH cn fn n DEC : 29 40 107 pL pH cn fn n HEX : 1D 28 6b pL pH cn fn n																
Function	Setting error correction level of QR code																
Parameter range	pL=3, pH=0 cn=49 fn=69 $48 \leq n \leq 51$																
Default	n=48																
Notes	Setting error correction level of QR code <table border="1" style="margin-left: 20px;"> <thead> <tr> <th>n</th> <th>Function</th> <th>Approximate Amount of correction</th> </tr> </thead> <tbody> <tr> <td>4 8</td> <td>Error correction level (L)</td> <td>7%</td> </tr> <tr> <td>4 9</td> <td>Error correction level (M)</td> <td>15%</td> </tr> <tr> <td>5 0</td> <td>Error correction level(Q)</td> <td>25%</td> </tr> <tr> <td>5 1</td> <td>Error correction level (H)</td> <td>30%</td> </tr> </tbody> </table>		n	Function	Approximate Amount of correction	4 8	Error correction level (L)	7%	4 9	Error correction level (M)	15%	5 0	Error correction level(Q)	25%	5 1	Error correction level (H)	30%
n	Function	Approximate Amount of correction															
4 8	Error correction level (L)	7%															
4 9	Error correction level (M)	15%															
5 0	Error correction level(Q)	25%															
5 1	Error correction level (H)	30%															
Example	None																

Store QR code data to QR code data buffer

Name	Store QR bar code data to QR code data buffer	
Code	ASCII : GS (k pL pH cn fn m d1...dk DEC : 29 40 107 pL pH cn fn m d1...dk HEX : 1D 28 6b pL pH cn fn m d1...dk	
Function	Store QR bar code data to data buffer	
Parameter range	$4 \leq (pL + pH \times 256) \leq 7092$ ($0 \leq pL \leq 255$, $0 \leq pH \leq 28$) cn=49 fn=80 m=48 $0 \leq d \leq 255$ $k = (pL + pH \times 256) - 3$	

Default	No
Notes	Store QR bar code data (d1...dk) to data buffer. ((pL + pH×256) - 3) bytes is processed as a graphic data after the m (d1...dk).
Example	None
Name	Store QR bar code data to data buffer

Printing QR bar code

Name	Printing QR bar code
Code	ASCII : GS (k pL pH cn fn m DEC : 29 40 107 pL pH cn fn m HEX : 1D 28 6b pL pH cn fn m
Function	Printing QR code
Parameter range	pL=3, pH=0 cn=49 fn=81 m=48
Default	None
Notes	Printing QR bar code. Users must consider QR bar code graph space. (The space of up and down, left and right of two-dimension bar code graph is specified in the specification.)
Example	1b 40 1d 28 6b 03 00 31 43 03 1d 28 6b 03 00 31 45 30 1d 28 6b 06 00 31 50 30 41 42 43 1b 61 01 1d 28 6b 03 00 31 52 30 1d 28 6b 03 00 31 51 30
Name	Printing QR bar code

Setting QR code graph information

Name	Setting QR code graph information
Code	ASCII : GS (k pL pH cn fn m DEC : 29 40 107 pL pH cn fn m HEX : 1D 28 6b pL pH cn fn m

Function	Setting QR code graph information																																												
	The detailed graph information is as follows:																																												
	<table border="1"> <thead> <tr> <th>Transmit data</th> <th>Hexadecimal</th> <th>Decimal</th> <th>Data type</th> </tr> </thead> <tbody> <tr> <td>Header</td> <td>37H</td> <td>55</td> <td>1byte</td> </tr> <tr> <td>Flag</td> <td>36H</td> <td>54</td> <td>1byte</td> </tr> <tr> <td>Width</td> <td>30H-39H</td> <td>48-57</td> <td>1-5byte</td> </tr> <tr> <td>Separator</td> <td>1FH</td> <td>31</td> <td>1byte</td> </tr> <tr> <td>Height</td> <td>30H-39H</td> <td>48-57</td> <td>1-5byte</td> </tr> <tr> <td>Separator</td> <td>1FH</td> <td>31</td> <td>1byte</td> </tr> <tr> <td>Fixed Value</td> <td>31H</td> <td>49</td> <td>1byte</td> </tr> <tr> <td>Separator</td> <td>1FH</td> <td>31</td> <td>1byte</td> </tr> <tr> <td>Other Information</td> <td>30H or 31H</td> <td>48 or 49</td> <td>1byte</td> </tr> <tr> <td>NUL</td> <td>00H</td> <td>0</td> <td>1byte</td> </tr> </tbody> </table>	Transmit data	Hexadecimal	Decimal	Data type	Header	37H	55	1byte	Flag	36H	54	1byte	Width	30H-39H	48-57	1-5byte	Separator	1FH	31	1byte	Height	30H-39H	48-57	1-5byte	Separator	1FH	31	1byte	Fixed Value	31H	49	1byte	Separator	1FH	31	1byte	Other Information	30H or 31H	48 or 49	1byte	NUL	00H	0	1byte
	Transmit data	Hexadecimal	Decimal	Data type																																									
	Header	37H	55	1byte																																									
	Flag	36H	54	1byte																																									
	Width	30H-39H	48-57	1-5byte																																									
	Separator	1FH	31	1byte																																									
	Height	30H-39H	48-57	1-5byte																																									
	Separator	1FH	31	1byte																																									
Fixed Value	31H	49	1byte																																										
Separator	1FH	31	1byte																																										
Other Information	30H or 31H	48 or 49	1byte																																										
NUL	00H	0	1byte																																										
and H data transmit graph: use dot for unit.																																													
Other information data transmit:																																													
“Hexadecimal=30H/Decimal=48”: Data is not printed.																																													
“Hexadecimal=31H/Decimal=49”: Data is not printed.																																													
Parameter range	pL=3, pH=0 cn=49 fn=82 m=48																																												
Default	None																																												
Notes	This command do not print QR code graph. Users must consider QR code graph space. (The space of up and down, left and right of QR code graph is specified in the specification.)																																												
Example	None																																												

Printing two dimensional code

Name	Printing two dimensional code
Code	ASCII : GS k m v r nL nH d1...dk DEC : 29 107 97 v r nL nH d1...dk HEX : 1D 6B 61 v r nL nH d1...dk
Function	Printing two dimensional code. v: describes two dimensional code specification v=0: describes automatically select two dimensional code specification r: describes error correction rank

	nL nH: describes data length d1...dk: describes two dimensional code to be printed
Parameter range	$0 \leq v \leq 17$ $1 \leq r \leq 4$ $k = nL + 256 * nH$
Default	None
Notes	Printing QR code.
Example	1b 40 1D 6B 61 08 02 08 00 30 31 32 33 34 35 36 37

Printing double QR code

Name	Printing double QR code
Code	ASCII : US Q m n p1H p1L l1H l1L ecc1 v1 d1...dn p2H p2L l2H l2L ecc2 v2 dk...dm DEC : 27 81 m n p1H p1L l1H l1L ecc1 v1 d1...dn p2H p2L l2H l2L ecc2 v2 dk...dm HEX : 1F 51 m n p1H p1L l1H l1L ecc1 v1 d1...dn p2H p2L l2H l2L ecc2 v2 dk...dm
Function	Printing double QR code
Range	QR code numbers: 0<m>3 QR code size: n(1~8) P1H,p1L specify the location of QR1: (p1H*256+p1L) l1H,l1L specify the data length of QR1: (l1H*256+l1L) Ecc1 specify error correction level about QR1 : (0:7%, 1:15%,2:25%,3:30%) V1 specify QR1 version of the symbol.(1~40, 0:auto size) D1...d2 as the data of QR1; P2H,p2L specify the location of QR2: (p2H*256+p2L) l2H,l2L specify the data length of QR2: (l2H*256+l2L) Ecc2 specify error correction level about QR2 : (0:7%, 1:15%,2:25%,3:30%) V2 specify QR2 version of the symbol.(1~40, 0:auto size) Dk...dm as the data of QR2
Default	None
Notes	If module size is bigger than printing width, the QR data will be treated as normal data
Example	To Print string "0123456789" in QR Code at position 32 with ecc 1and Print string "987654321" in QR Code at position 192 with ecc 2, and module size 3, you should send command as follow。 1f 51 02 03 00 20 00 0a 01 06 30 31 32 33 34 35 36 37 38 39 00 C0 00 0a 02 00 39 38 37 36 35 34 33 32 31 30

⑧ Other commands

Printer reset

Name	Printer reset
Code	ASCII : ESC @ Decimal : 27 64 Hex : 1B 40
Function	The ESC @ command initializes the printer as following: This command prints the data contained in the print buffer, and initializes various setup items. Restore default values for each parameter
Range	None
Default value	None
Notes	None
Example	None

Print self-test page

Name	Print self-test page
Code	ASCII : DC2 T Decimal : 18 84 Hex : 12 54
Function	Printing a self-test page which including firmware version, interface, codepage and other some information
Range	None
Default value	None
Notes	None
Example	1B 40 12 54