

# KP-347 Printer module

## User Manual



Draft : Lin zhiping 2018.02.06

Audit : Hu Riyu 2018.02.08

Standardize : Liu Zhonghua 2018.02.09

Authorize : Wang Huanyong 2018.02.11

Tel: 0592-5517253 Fax: 0592-5231815

Company: Xiamen Cashino Technology Co., Ltd.

Address: 4/F,No.318,Tongji South Road, Jimei District,Xiamen,China.361021

The manual is subject to change without further notice. Please contact Xiamen Cashino Technology Co., Ltd. directly for the latest



凱 勝 諾

# 厦门凯胜诺科技有限公司

XIAMEN CASHINO TECHNOLOGY CO.,LTD.

F,No.322 of 109 ,Tongji South Road,Jimei District,Xiamen,China.361021 ( Zongshun Business Building)  
Tel:+86-0592-5517253 Fax:+86-0592-5213815 E-mail:sales@csntek.com

## Revision Record

No.	Date	Content of Modify	Number of the Page	Preparation / modification	Review
1	20180206	First draft		Lin Xiaopeng	Hu Riyu
2	20170821	Specification	6	Zhu chunyan	Hu Riyu



凱 勝 諾

厦门凯胜诺科技有限公司

XIAMEN CASHINO TECHNOLOGY CO.,LTD.

F,No.322 of 109 ,Tongji South Road,Jimei District,Xiamen,China.361021 ( Zongshun Business Building)  
Tel:+86-0592-5517253 Fax:+86-0592-5213815 E-mail:sales@csntek.com

## Contents

1.Overview.....	5
2. Production feature.....	5
3. Products Model named rules.....	5
4. Specification.....	6
5.Dimensions.....	7
6. Connector pin specification.....	7
7. Basic Operation.....	8
7.1 Printing self-test page.....	8
7.2 LED.....	9
7.3 Paper roll placement.....	9
7.4 Paper roll installation.....	10
7.5 Exclude cutter jams and paper jams.....	10
8. Command Introduction.....	10
8.1 Command List.....	11
8.2 Commands details.....	12
①Printing and paper feed commands.....	12
Printing and paper feed.....	12
Enter.....	12
Print and paper feed n dots.....	13
Print and paper feed n line.....	13
② Printing set commands.....	13
Character right space setting.....	13
Set line space as n dots.....	14
Set line space to default.....	14
Set character print font.....	15
Set character printing method.....	15
Set character size.....	16
Set、 remove white printing.....	17
Set、 remove underline.....	17
Set、 remove bold print.....	18
Set、 remove overlapping.....	18
Set、 cancel characters upside down.....	19
Set、 remove 90°revolving printing.....	19
Allow、 Forbid key switch.....	19
Set the left margin.....	20
Set printing alignment.....	20
Select、 cancel user customized characters.....	21
Define user customized characters.....	21
Cancel user customized characters.....	23



# 厦门凯胜诺科技有限公司

XIAMEN CASHINO TECHNOLOGY CO.,LTD.

凱 勝 諾

F,No.322 of 109 ,Tongji South Road,Jimei District,Xiamen,China.361021 ( Zongshun Business Building)  
Tel:+86-0592-5517253 Fax:+86-0592-5213815 E-mail:sales@csntek.com

---

Set / remove quadruple angle of Chinese print.....	24
Set the Angle of Chinese character word space.....	24
Set up the Chinese characters to print mode combination.....	25
Set Chinese mode.....	25
Exit Chinese character mode.....	26
Set and cancel under line of Chinese character mode.....	26
Set and cancel under line of Chinese character mode.....	26
Selecting international character set.....	27
Select character code.....	27
③Graphic printing command.....	29
Fill Graphics vertical module data.....	29
Print Graphics horizontal module data.....	31
Define downloaded bitmap.....	32
Print downloaded bitmap.....	33
Define NV bitmap.....	34
Print NV bitmap.....	37
④Tab Commands.....	38
Horizontal tab.....	38
Horizontal tab position setting.....	38
⑤One-dimension bar code command.....	39
1D bar code readable character(HRI) print position setting.....	39
1D bar code height setting.....	40
1D bar code width setting.....	40
1D bar code printing.....	40
⑥ Two-dimensional bar code commands.....	46
Printing QR code.....	46
Printing two dimensional code.....	46
Printing double QR code.....	47
⑦Status querying Commands.....	48
Real-time transmission status.....	48
Real-time transmission status.....	48
⑧Other commands.....	51
Printer reset.....	51
Print self-test page.....	52
Paper cut.....	52
Full cut.....	53
Partial cut.....	53



凱 勝 諾

# 厦门凯胜诺科技有限公司

XIAMEN CASHINO TECHNOLOGY CO.,LTD.

F, No.322 of 109, Tongji South Road, Jimei District, Xiamen, China.361021 ( Zongshun Business Building)  
Tel: +86-0592-5517253 Fax: +86-0592-5213815 E-mail: sales@csntek.com

## 1. Overview

KP-347 is a 3 inch self-service terminal embedded printer module composed of a thermal printer mechanism with cutter and a control board. It is widely used in financial self-service terminals、communication self-service terminals、coupon self-service terminals、ticket self-service terminals、power self-service terminals、medical self-service terminals、insurance self-service terminals、tax self-service terminals、library self-service terminals and other self-service terminals ;fuel dispensers、parking lot management 、 queuing machine etc.

## 2. Production feature

- ① Beautiful appearance
- ② Compatible with ESC/POS printing command
- ③ Low noise thermal printing
- ④ RS232transmission rate up to 115200bps
- ⑤ Support dual QRCODE printing

## 3. Products Model named rules

Example      KP-347    H    R    N    S    N  
                   (a)    (b)    (c)    (d)    (e)    (f)

(a)	Model name	KP-347
(b)	Default function	H: Horizontal bracket V: Vertical bracket N: Without bracket
(c)	Default function	R: RS232+USB T: TTL+USB
(d)	Optional function	N : Drawer kick function D: Without Drawer kick function
(e)	Optional function	S: Paper near end sensor, N: Without paper near end sensor,
(f)	Optional function	S: Take out paper sensor N: Without Take out paper sensor



凱 勝 諾

# 厦门凯胜诺科技有限公司 XIAMEN CASHINO TECHNOLOGY CO.,LTD.

F,No.322 of 109 ,Tongji South Road,Jimei District,Xiamen,China.361021 ( Zongshun Business Building)  
Tel:+86-0592-5517253 Fax:+86-0592-5213815 E-mail:sales@csntek.com

## 4. Specification

Printing	Print method	Thermal line printing
	Print speed	Max:200mm/s
	Resolution	8dots/mm ,203dpi
	Effective printing width	72mm
Character	Character set	ASCII , GBK , BIG5 etc
	Font	ANK : (9*17,12*24) Chinese : ( 24*24 )
	Printable characters per line	Font A ( 12*24 ) : 48 ; Font B ( 9*17 ) : 64 ; GBK : 16
Paper spec.	Paper type	Thermal paper
	Paper width	80mm
	Paper Thickness	55-85µm
	Paper diameter	Max:80mm;min:13mm
Detection	Printer head temperature	Thermistor
	Out of paper	Photoelectric detection
	Paper near end	Photoelectric detection
	Take out paper sensor ( Optional )	Photoelectric detection
Baudrate		9600bps-115200bps
Interface		Serial ( RS232/TTL ) , USB , Cash drawer
1D code		UPC-A, UPC-E, JAN/EAN8, JAN/EAN13, CODE39, ITF, CODEBAR, CODE128, CODE93
2D code		QR Code
Printing life		> 100Km
Pulse		100 million pulses or more (printing rate 12.5%)
Cutter life		> 1 million times
Auto cutter		Full cut + partial cut
Power (Adaptor)		DC24V/2A
Cash Drawer ( Optional )		DC24V/1A
Command		ESC/POS
Driver		Windows Driver, Linux Driver
Environmental	Operating temperature	0°C~50°C

conditions	Operating humidity	20%RH ~85% RH
	Storage temperature	-20°C~60°C
	Storage humidity	5% ~90%RH
Outline Dimension	Horizontal ( W*L*H )	110.7*113.2*81.2mm
	Vertical ( W*L*H )	110.7*55.9*138.7mm

## 5. Dimensions

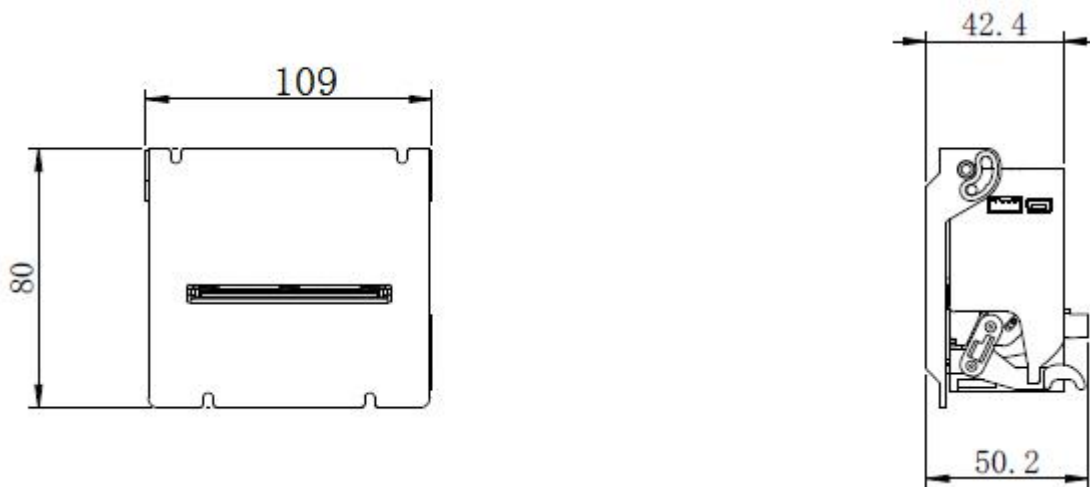

## 6. Connector pin specification

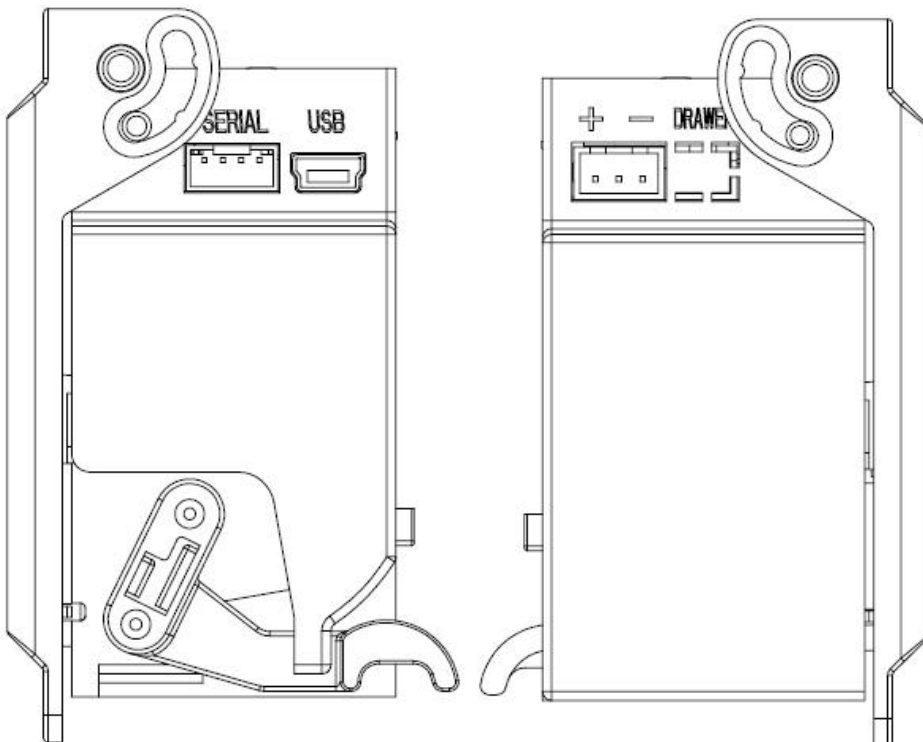

## Serial 4Pin/PH2.0mm

Terminal No.	Signal Name	Description
1	GND	Ground
2	RXD	Receive data
3	TXD	Transmission data
4	DTR	Request to send (Data terminal ready)

## Mini USB

Terminal No.	Signal Name	Description
1	GND	Ground
2	D+	Data line positive
3	D-	Data line negative
4	VUSB	Power supply

## Power 3Pin/XH2.54mm

Terminal No.	Signal Name	Description
1	GND	Ground
2	NUL	Blank
3	VH	Power supply

## Drawer 2Pin/XH2.54mm

Terminal No.	Signal Name	Description
1	GND	Ground
2	VH	Power supply

# 7. Basic Operation

## 7.1 Printing self-test page

Method 1 : Power off while holding the feed button depressed. Then take power on ,self-test receipt will print out.It's including baud rate language and other some information.

Method 2 : Power on, press the printing button for 3s, printer will print a self-test page.





## 7.2 LED

The printer has two indicators remind user the status of the printer. The two indicators are the power indicator and the status ERROR indicator.

Power indicator	Statue indicator	Printer status
Bright	Light off	Normal
Bright	Flash 2 times	Printer head is not connected or the temperature is too low
Bright	Flash 3 times	Out of paper
Bright	Flash 4 times	Cutter error
Bright	Flash 5 times	Printer head overheating
Bright	Flash 6 times	paper roller is not loaded properly

## 7.3 Paper roll placement

KP-347 have two paper roll placements: horizontal/vertical for optional, show as follow:

### Horizontal

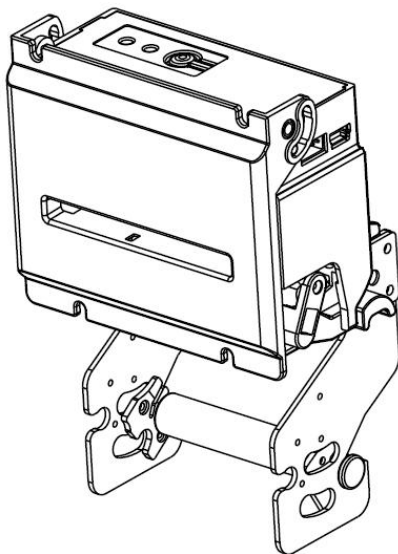

### Vertical

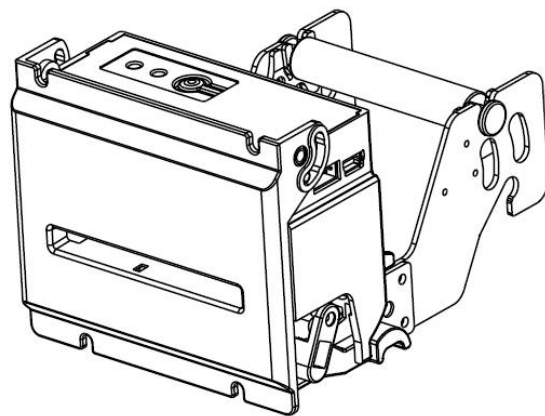

## 7.4 Paper roll installation

When the printer is powered on, the side with thermal coating of the thermal paper faces up and is placed in the paper loading port of the printer, with the sound of paper moving from the mechanism, it will automatically absorb the paper. When loading paper, the paper end must be flattened. The length of the paper inserted into the paper feed port must be more than 20 mm. If the gear is rotated, the paper is still not automatically fed. Please continue to insert manually.

### Horizontal

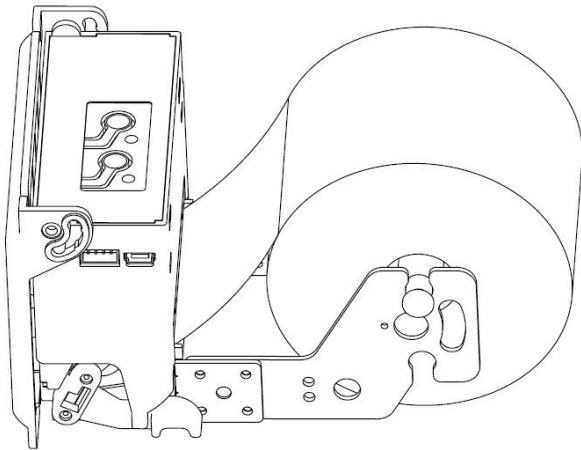

### Vertical

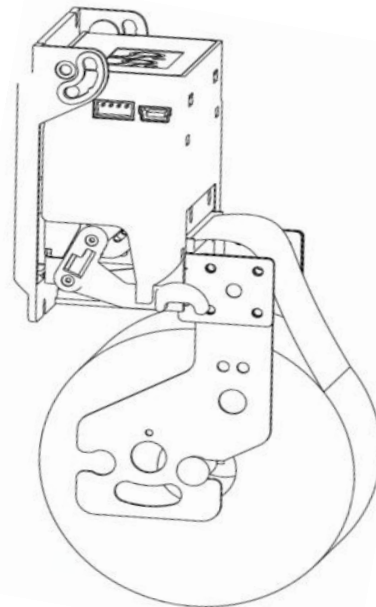

## 7.5 Exclude cutter jams and paper jams

Exclude cutter jams: Reset the cutter by turning it off and then turning it on. If it cannot be reset, reset the cutter by repeatedly turning the cover wrench.

Exclude paper jams: Exclude the cutter jams, then open the top cover to remove the jammed paper.

## 8. Command Introduction

The printer is compatible with EPSON ESC/POS command, and it had passed the test of command functions, more details as follow.



凱 勝 諾

# 厦门凯胜诺科技有限公司

## XIAMEN CASHINO TECHNOLOGY CO.,LTD.

F,No.322 of 109 ,Tongji South Road,Jimei District,Xiamen,China.361021 ( Zongshun Business Building)  
Tel:+86-0592-5517253 Fax:+86-0592-5213815 E-mail:sales@csntek.com

### 8.1 Command List

LF	Line feed	Print, paper feed Command
CR	Enter	
ESC J n	Print and paper feed n dots	
ESC d n	Print and paper feed n lines	
ESC 3 n	Set line space as n dots	Printing-set Command
ESC 2	Set default line space	
ESC \$	Set printing position	
GS L nL nH	Set the amount of left margin	
ESC !	Set character printing method	
GS ! n	Set character printing method	
GS B n	Set, remove white printing	
ESC - n	Set, remove underline	
ESC V n	Set, remove 90°revolving printing	
ESC a	Setting position alignment mode	
FS &	Set Chinese character mode	
FS .	Cancel Chinese character mode	
ESC % n	Select 、 Cancel user customized character	
ESC &	Define user customized character	
ESC ? n	Cancel user customized character	
ESC R n	Select International character	
ESC t n	Select the character code page	
ESC *	Bitmap vertical modulus data fillings	Bitmap Command
GS v 0	Bitmap horizontal modulus data print	
GS *	Define Downstream bitma	
GS / m	Print Downstream bitmap	
FS q	Define NV bitmap	
FS p n m	Print NV bitmap	Tab Command
HT	Horizontal tab	
ESC D	Set horizontal tabulation position	1-D barcode Command
GS H	Set 1-D barcode readable	



凱 勝 諾

# 厦门凯胜诺科技有限公司

## XIAMEN CASHINO TECHNOLOGY CO.,LTD.

F.No.322 of 109 ,Tongji South Road,Jimei District,Xiamen,China.361021 ( Zongshun Business Building)  
Tel:+86-0592-5517253 Fax:+86-0592-5213815 E-mail:sales@csntek.com

	character(HRI) print position	
GS h	Set 1-D barcoe hight	
GS w	Set 1-D barcode width	
GS k	Print 1-D barcode	
GS ( k pL pH cn fn m	Print QR CODE	QR CODE Command
GS k m v r nL nH d1...dk	Print two-dimensional bar code	
US Q m n	Print double QR CODE	
DLE EOT n	Real-time transmission status	Status Inquire Command
ESC @	Printer reset	Other Commands
DC2 T	Printing self-test page	
ESC i	Full cut	
ESC m	Partial cut	

## 8.2 Commands details

### ①Printing and paper feed commands

#### Printing and paper feed

Name	print and paper feed
Code	ASCII : LF DEC : 10 HEX : 0A
Function	Print the buffer contest,and set the paper feed as per line space,then adjust print position to initial position at the next line.
Range	None
Default	None
Notes	None
Example	None

#### Enter

Name	Enter
------	-------



凱 勝 諾

# 厦门凯胜诺科技有限公司 XIAMEN CASHINO TECHNOLOGY CO.,LTD.

F.No.322 of 109 ,Tongji South Road,Jimei District,Xiamen,China.361021 ( Zongshun Business Building)  
Tel:+86-0592-5517253 Fax:+86-0592-5213815 E-mail:sales@csntek.com

Code	ASCII : CR DEC : 13 HEX : 0D
Function	Adjust print position to initial position of the same line.
Range	None
Default	None
Notes	After executing, R command, the new printing data will cover old data in the printing buffer.
Example	None

## Print and paper feed n dots

Name	Print and paper feed n dots
Code	ASCII : ESC J n DEC : 27 74 n HEX : 1B 4A n
Function	Print the buffer content and paper feed
Range	$0 \leq n \leq 255$
Default	None
Notes	Paper feed n dots when printing buffer is empty. After executing this command, printing position is moved to initial
Example	1b 40 30 31 32 1b 4a 10

## Print and paper feed n line

Name	Print and paper feed n lines
Code	ASCII : ESC d n DEC : 27 100 n HEX: 1B 64 n
Function	Print the contents in printing buffer and paper feed n lines.
Range	$0 \leq n \leq 255$
Default	None
Notes	Print this command set as initial position of the same line
Example	1b 40 30 31 32 1b 64 01

## ② Printing set commands

### Character right space setting

Name	Character right space setting
Code	ASCII : ESC SP n DEC : 27 32 n HEX : 1B 20 n



凱 勝 諾

# 厦门凯胜诺科技有限公司

XIAMEN CASHINO TECHNOLOGY CO.,LTD.

F,No.322 of 109 ,Tongji South Road,Jimei District,Xiamen,China.361021 ( Zongshun Business Building)  
Tel:+86-0592-5517253 Fax:+86-0592-5213815 E-mail:sales@csntek.com

Function	Character right space setting as (n*0.125mm)
Range	0 ≤ n ≤ 255
Default	n = 0
Notes	When characters double width,Character right space is twice of normal.When characters amplified,Character right space is n times of normal. This command doesn't affect the setting of Chinese characters. This command sets the standard values independently in each mode.
Example	None

## Set line space as n dots

Name	Set line space as n dots
Code	ASCII : ESC 3 n DEC : 27 51 n HEX : 1B 33 n
Function	Set line space as n dots
Range	0 ≤ n ≤ 255
Default	n = 33
Notes	Line space as below:  If the line space setted is less than the highest character in that line,then this line space is equal to the height of the highest character. If ESC2,ESC@,reset the printer, the printer blackout,and the line space turns to default.
Example	1b 40 1b 33 30 30 31 32 0d 0a 30 31 32 0d 0a 1b 32 30 31 32 0d 0a 30 31 32 0d 0a

## Set line space to default

Name	Set line space to default
Code	ASCII : ESC 2 DEC: 27 50 HEX : 1B 32
Function	Set line space to default 30 dots
Range	None



凱 勝 諾

廈門凱勝諾科技有限公司

XIAMEN CASHINO TECHNOLOGY CO.,LTD.

F,No.322 of 109 ,Tongji South Road,Jimei District,Xiamen,China.361021 ( Zongshun Business Building)  
Tel:+86-0592-5517253 Fax:+86-0592-5213815 E-mail:sales@csntek.com

Default	None
Notes	Line space in details pls check ESC 3 command. If the line space setted is less than the height character in the line,the line space of this line is equal to the height of the highest character It can use ESC 3 to define line space.
Example	None

### Set character print font

Name	set character print font
Code	ASCII : ESC M n DEC : 27 77 n HEX : 1B 4D n
Function	set character print font parameter n bit definition as below n = 0, font 12*24 n = 1, font 9*17
Range	None
Default	n = 0
Notes	The command is effective with character. The command is disabled when ESC@, printer reset or blackout.
Example	1B 40 1B 4D 00 30 31 32 0D 0A 1B 40 1B 4D 01 30 31 32 0D 0A

### Set character printing method

Name	Set character printing method
Code	ASCII : ESC ! n DEC : 27 33 n HEX: 1B 21 n
Function	Set character printing methods(font,highlight,inversion,bold,double hight,double width and underline),parameter n bit definition as below: <b>Bit Function Value</b> <b>0 1</b> 0 Font Normal Small character 1 Undefined 2 Undefined 3Bold Cancel Setting 4 Double hight Cancel Setting 5 Double width Cancel Setting 6 Undefined 7 Underline Cancel Setting
Range	None



凱 勝 諾

廈門凱勝諾科技有限公司

XIAMEN CASHINO TECHNOLOGY CO.,LTD.

F,No.322 of 109 ,Tongji South Road,Jimei District,Xiamen,China.361021 ( Zongshun Business Building)  
Tel:+86-0592-5517253 Fax:+86-0592-5213815 E-mail:sales@csntek.com

Default	n = 0
Notes	The command is effective with Chinese and foreign languages. The command is disabled when ESC@, printer reset or power off
Example	1B 40 1B 21 01 30 31 32 0D 0A 1B 40 1B 21 02 30 31 32 0D 0A 1B 40 1B 21 04 30 31 32 0D 0A 1B 40 1B 21 08 30 31 32 0D 0A 1B 40 1B 21 10 30 31 32 0D 0A 1B 40 1B 21 20 30 31 32 0D 0A 1B 40 1B 21 40 30 31 32 0D 0A 1B 40 1B 21 80 30 31 32 0D 0A

### Set character size

Name	Set character size																																																												
Code	ASCII : GS ! n DEC : 29 33 n HEX : 1d 21 n																																																												
Function	<p>Set character size as 1-8 times width,1-8 times height. Definition is as below: Use 0-3 set character height 4 - 7 bits set character width show as below:</p> <table style="width: 100%; border-collapse: collapse;"> <thead> <tr> <th style="text-align: left;">Chart 1</th> <th style="text-align: left;">Chart 2</th> </tr> <tr> <th style="text-align: center;">Character width setting</th> <th style="text-align: center;">Character height setting</th> </tr> </thead> <tbody> <tr> <td style="border: 1px solid black; text-align: center;"> <table border="1" style="width: 100%; border-collapse: collapse;"> <thead> <tr> <th>HEX</th> <th>DEC</th> <th>width</th> </tr> </thead> <tbody> <tr><td>00</td><td>0</td><td>1(Normal)</td></tr> <tr><td>10</td><td>16</td><td>2(double width)</td></tr> <tr><td>20</td><td>32</td><td>3</td></tr> <tr><td>30</td><td>48</td><td>4</td></tr> <tr><td>40</td><td>64</td><td>5</td></tr> <tr><td>50</td><td>80</td><td>6</td></tr> <tr><td>60</td><td>96</td><td>7</td></tr> <tr><td>70</td><td>112</td><td>8</td></tr> </tbody> </table> </td> <td style="border: 1px solid black; text-align: center;"> <table border="1" style="width: 100%; border-collapse: collapse;"> <thead> <tr> <th>HEX</th> <th>DEC</th> <th>height</th> </tr> </thead> <tbody> <tr><td>00</td><td>0</td><td>1(Normal)</td></tr> <tr><td>01</td><td>1</td><td>2(double height)</td></tr> <tr><td>02</td><td>2</td><td>3</td></tr> <tr><td>03</td><td>3</td><td>4</td></tr> <tr><td>04</td><td>4</td><td>5</td></tr> <tr><td>05</td><td>5</td><td>6</td></tr> <tr><td>06</td><td>6</td><td>7</td></tr> <tr><td>07</td><td>7</td><td>8</td></tr> </tbody> </table> </td> </tr> </tbody> </table>	Chart 1	Chart 2	Character width setting	Character height setting	<table border="1" style="width: 100%; border-collapse: collapse;"> <thead> <tr> <th>HEX</th> <th>DEC</th> <th>width</th> </tr> </thead> <tbody> <tr><td>00</td><td>0</td><td>1(Normal)</td></tr> <tr><td>10</td><td>16</td><td>2(double width)</td></tr> <tr><td>20</td><td>32</td><td>3</td></tr> <tr><td>30</td><td>48</td><td>4</td></tr> <tr><td>40</td><td>64</td><td>5</td></tr> <tr><td>50</td><td>80</td><td>6</td></tr> <tr><td>60</td><td>96</td><td>7</td></tr> <tr><td>70</td><td>112</td><td>8</td></tr> </tbody> </table>	HEX	DEC	width	00	0	1(Normal)	10	16	2(double width)	20	32	3	30	48	4	40	64	5	50	80	6	60	96	7	70	112	8	<table border="1" style="width: 100%; border-collapse: collapse;"> <thead> <tr> <th>HEX</th> <th>DEC</th> <th>height</th> </tr> </thead> <tbody> <tr><td>00</td><td>0</td><td>1(Normal)</td></tr> <tr><td>01</td><td>1</td><td>2(double height)</td></tr> <tr><td>02</td><td>2</td><td>3</td></tr> <tr><td>03</td><td>3</td><td>4</td></tr> <tr><td>04</td><td>4</td><td>5</td></tr> <tr><td>05</td><td>5</td><td>6</td></tr> <tr><td>06</td><td>6</td><td>7</td></tr> <tr><td>07</td><td>7</td><td>8</td></tr> </tbody> </table>	HEX	DEC	height	00	0	1(Normal)	01	1	2(double height)	02	2	3	03	3	4	04	4	5	05	5	6	06	6	7	07	7	8
Chart 1	Chart 2																																																												
Character width setting	Character height setting																																																												
<table border="1" style="width: 100%; border-collapse: collapse;"> <thead> <tr> <th>HEX</th> <th>DEC</th> <th>width</th> </tr> </thead> <tbody> <tr><td>00</td><td>0</td><td>1(Normal)</td></tr> <tr><td>10</td><td>16</td><td>2(double width)</td></tr> <tr><td>20</td><td>32</td><td>3</td></tr> <tr><td>30</td><td>48</td><td>4</td></tr> <tr><td>40</td><td>64</td><td>5</td></tr> <tr><td>50</td><td>80</td><td>6</td></tr> <tr><td>60</td><td>96</td><td>7</td></tr> <tr><td>70</td><td>112</td><td>8</td></tr> </tbody> </table>	HEX	DEC	width	00	0	1(Normal)	10	16	2(double width)	20	32	3	30	48	4	40	64	5	50	80	6	60	96	7	70	112	8	<table border="1" style="width: 100%; border-collapse: collapse;"> <thead> <tr> <th>HEX</th> <th>DEC</th> <th>height</th> </tr> </thead> <tbody> <tr><td>00</td><td>0</td><td>1(Normal)</td></tr> <tr><td>01</td><td>1</td><td>2(double height)</td></tr> <tr><td>02</td><td>2</td><td>3</td></tr> <tr><td>03</td><td>3</td><td>4</td></tr> <tr><td>04</td><td>4</td><td>5</td></tr> <tr><td>05</td><td>5</td><td>6</td></tr> <tr><td>06</td><td>6</td><td>7</td></tr> <tr><td>07</td><td>7</td><td>8</td></tr> </tbody> </table>	HEX	DEC	height	00	0	1(Normal)	01	1	2(double height)	02	2	3	03	3	4	04	4	5	05	5	6	06	6	7	07	7	8						
HEX	DEC	width																																																											
00	0	1(Normal)																																																											
10	16	2(double width)																																																											
20	32	3																																																											
30	48	4																																																											
40	64	5																																																											
50	80	6																																																											
60	96	7																																																											
70	112	8																																																											
HEX	DEC	height																																																											
00	0	1(Normal)																																																											
01	1	2(double height)																																																											
02	2	3																																																											
03	3	4																																																											
04	4	5																																																											
05	5	6																																																											
06	6	7																																																											
07	7	8																																																											
Range	None																																																												
Default	n = 0																																																												
Notes	This command is effective with Chinese and other foreign languages, except for HRI character. The command setting is disable when ESC@, printer reset or power off.																																																												
Example	1b 40 1d 21 11 30 31 32 0d 0a 30 31 32 0d 0a																																																												





凱 勝 諾

廈門凱勝諾科技有限公司

XIAMEN CASHINO TECHNOLOGY CO.,LTD.

F,No.322 of 109 ,Tongji South Road,Jimei District,Xiamen,China.361021 ( Zongshun Business Building)  
Tel:+86-0592-5517253 Fax:+86-0592-5213815 E-mail:sales@csntek.com

## Set、 remove white printing

Name	Set、 remove white printing
Code	ASCII : GS B n DEC : 29 66 n HEX : 1d 42 n
Function	Set and remove white printing When the LSB of n is 0,white printing mode is off. When the LSB of n is 1,white printing mode is on.
Range	None
Default	n = 0
Notes	It is only effective for LSB of n. This command is all effective with built-in characters and user-defined characters. It is effective with blank,which is setted by ESC CP,when white printing mode is on. This command is not effective with bitmap, user-defined bitmap, barcode, HRI character and vaulting space of HT,ESC \$. This command is not effective with line space. The white printing mode is prior to underline mode. When it is white printing mode, even underline mode is open, which can also be forbidden.(But it not be canceled). This command is disabled when ESC@, printer reset or power off.
Example	1b 40 1d 42 01 30 31 32 0d 0a 30 31 32 0d 0a

## Set、 remove underline

Name	Set、 remove underline								
Code	ASCII : ESC - n DEC : 27 45 n HEX : 1B 2D n								
Function	Set/ remove underline mode,based on the value of n as follow: <table border="1" style="margin-left: 20px;"> <thead> <tr> <th>n</th> <th>Functions</th> </tr> </thead> <tbody> <tr> <td>0, 48</td> <td>Remove underline mode</td> </tr> <tr> <td>1, 49</td> <td>Set underline mode(1dotcoarse)</td> </tr> <tr> <td>2, 50</td> <td>Set underline mode(2dotcoarse)</td> </tr> </tbody> </table>	n	Functions	0, 48	Remove underline mode	1, 49	Set underline mode(1dotcoarse)	2, 50	Set underline mode(2dotcoarse)
n	Functions								
0, 48	Remove underline mode								
1, 49	Set underline mode(1dotcoarse)								
2, 50	Set underline mode(2dotcoarse)								
Range	$0 \leq n \leq 2, 48 \leq n \leq 50$								
Default	n = 0								
Notes	Printer can print underline for all characters(including the space to the right of the character), except for the space set by HT. Printer can not print underline for clockwise rotated 90 ° characters and white printing characters. When n is setted as 0 or 48,remove underline mode.Other data is not printed as								



凱 勝 諾

廈門凱勝諾科技有限公司

XIAMEN CASHINO TECHNOLOGY CO.,LTD.

F,No.322 of 109 ,Tongji South Road,Jimei District,Xiamen,China.361021 ( Zongshun Business Building)  
Tel:+86-0592-5517253 Fax:+86-0592-5213815 E-mail:sales@csntek.com

	underline,and the setted underline coarseness does not change before removing underline mode.The default underline coarseness is 1 dot. It is not effective with underline coarseness to change character size. Using ESC! can also set and remove underline mode.However be aware that the last received command must be effective.
Example	1b 40 1b 2d 01 30 31 32 0d 0a 1b 40 1b 2d 02 30 31 32 0d 0a 1b 40 1b 2d 00 30 31 32 0d 0a

### Set, remove bold print

Name	Set 、 remove bold print
Code	ASCII : ESC E n DEC : 27 69 n HEX : 1B 45 n
Function	Set and remove bold print set and remove bold print When LSB of n is 0, remove bold print mode When MSB of n is 1, set bold print mode
Range	$0 \leq n \leq 255$
Default	n = 0
Notes	Only allow to use when LSB of n
Example	None

### Set, remove overlapping

Name	Set 、 remove overlapping
Code	ASCII : ESC G n DEC : 27 71n HEX : 1B 47 n
Function	Set and remove overlapping print mode When LSB of n is 0,remove overlapping print mode When MSB of n is 1,set overlapping print mode
Range	$0 \leq n \leq 255$
Default	n = 0
Notes	Only allow to use when LSB of n The printer output is the same in overlapping mode and bold mode
Example	None



凱 勝 諾

# 厦门凯胜诺科技有限公司 XIAMEN CASHINO TECHNOLOGY CO.,LTD.

F.No.322 of 109 ,Tongji South Road,Jimei District,Xiamen,China.361021 ( Zongshun Business Building)  
Tel:+86-0592-5517253 Fax:+86-0592-5213815 E-mail:sales@csntek.com

## Set、cancel characters upside down

Name	Set、cancel characters upside down
Code	ASCII : ESC { n DEC : 27 123 n HEX : 1B 7B n
Function	n=1: set character upside down n=0: cancel character upside down
Default	n=0
Notes	None
Example	None

## Set、remove 90°revolving printing

Name	Set 、remove 90°revolving printing
Code	ASCII : ESC V n DEC : 27 86 n HEX : 1B 56 n
Function	Set or remove 90°revolving printing When n is equal to 0 or 48,remove 90°revolving printing. When n is equal to 1 or 49,set 90°revolving printing.
Range	$0 \leq n \leq 1$ , $48 \leq n \leq 49$
Default	n = 0
Support Model	All
Notes	When it is setted to underline mode, the printer is not underlined for characters rotated 90°. In the 90° rotation mode, the multiplier and double width commands magnify the character in the opposite direction to the multiplier command in the normal mode. When ESC @, printer reset, power off, the setting of this instruction is invalid.
Example	1b 40 1b 56 01 30 31 32 0d 0a 30 31 32 0d 0a

## Allow、Forbid key switch

Name	Allow and forbid key switch
Code	ASCII : ESC c 5 n DEC : 27 99 53 n HEX : 1B 63 35 n
Function	n=1, Forbid key switch n=0,Allow key switch

Default	n = 0
Notes	None
Example	None

## Set the left margin

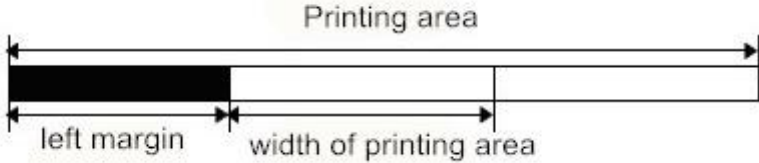
Name	Set the left margin
Code	ASCII : GS L nL nH DEC : 29 76 nL nH HEX : 1D 4C nL nH
Function	Set the left margin as (nL + nH × 256) dots
Range	0 ≤ nL ≤ 255, 0 ≤ nH ≤ 255
Default	None
Support Model	All
Notes	<p>This command is only effective with the initial position of the line. The illustration is as follows:</p>  <p style="text-align: right;">Use the</p> <p>maximum value of the printable unit,if the setting is beyond the printable area.</p>
Example	<pre>1b 40 1d 4c 08 00 30 31 32 0d 0a 30 31 32 0d 0a</pre>

## Set printing alignment

Name	Set print alignment (Left, middle, right)
Code	ASCII : ESC a n DEC : 27 97 n HEX : 1B 61 n
Function	Align all data in one line, the meaning of n values as below: n mode 0, 48 left 1, 49 middle 2, 50 right
Range	0 ≤ n ≤ 2 or 48 ≤ n ≤ 50
Default	n = 0
Notes	This command setting is disabled when ESC@, printer resets or power off.
Example	1B 40 1B 61 02



凱 勝 諾

# 厦门凯胜诺科技有限公司

## XIAMEN CASHINO TECHNOLOGY CO.,LTD.

F.No.322 of 109 ,Tongji South Road,Jimei District,Xiamen,China.361021 ( Zongshun Business Building)  
Tel:+86-0592-5517253 Fax:+86-0592-5213815 E-mail:sales@csntek.com

	30 31 32 0D 0A 1B 40 1B 61 01 30 31 32 0D 0A 1B 40 1B 61 00 30 31 32 0D 0A
--	--

### Select, cancel user customized characters

Name	Select 、 cancel user customized characters
Code	ASCII : ESC % n DEC : 27 37 n HEX : 1B 25 n
Function	Select 、 cancel user customized characters When n LSB is 0, delete customized characters When n LSB is 1, select customized characters
Range	$0 \leq n \leq 255$
Default	0
Notes	When cancel customized characters , automatically select the internal character set.
Example	None

### Define user customized characters

Name	Define user customized characters
Code	ASCII : ESC & y c1 c2 [x1 d1 ... d (yx1)] ... [xk d1 ... d(y x k)] DEC : 27 38 y c1 c2 [x1 d1 ... d(yx1)] ...[xk d1 ... d(yxk)] HEX : 1B 26 y c1 c2 [x1 d1...d(y x1)]...[xk d1...d(yxk)]
Function	Define user customized characters. y specifies vertical direction bytes. c1 specifies the starting character encoding,c2 specifies the ending character encoding xk specifies horizontal direction dots.
Range	The range of x 、 y, are correspond with internal fonts. If choosing Font 6*12, y = 2, $0 \leq x \leq 6$ If choosing Font 12*24, y= 3, $0 \leq x \leq 12$ $32 \leq c1 \leq c2 \leq 126$ $0 \leq d1 \dots d(y*xk) \leq 255$
Default	None
Notes	Definable character code range:from<20>H to <7E>H ASCII code(95 characters). It can define continuous characters encoding for several characters.When it need one character only,make c1=c2. d is character's dot data,dot mode starts from left side in the horizontal direction.It

is blank for the rest dots in the right side.

Defined user defines characters data is (y\*x) byte.

Set corresponding bit of printing dots as 1, or corresponding bit of no printing dots as 0.

This command defines different customized characters for each type of font. Set font with ESC !.

Customized characters and downlink bitmaps cannot be defined at the same time.

When the command is executed, the downlink bitmap is cleared.

User Customized characters will be cleared in these situations:

Execute ESC @。

Execute GS \*。

Execute ESC ?。

Printer reset or power off

Graphic:

When set font A(12 24).

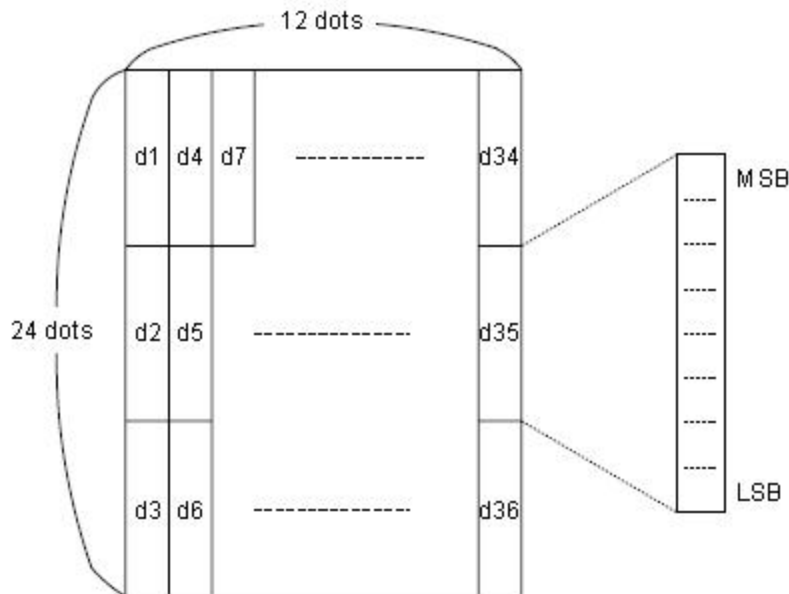

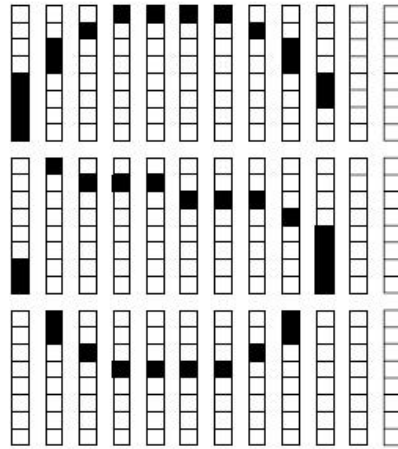
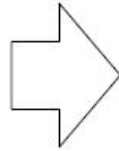
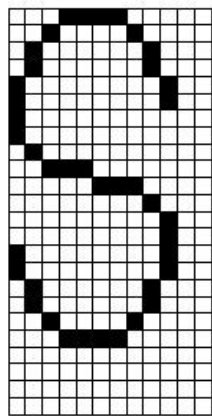

d1= <0F>H d4 = <30>H d7 = <40>H . . . .  
d2 = <03>H d5 = <80>H d8 = <40>H . . . .  
d3 = <00>H d6 = <00>H d9 = <20>H . . . .

Example

①y = 2  
1B 40  
1b 26 02 20 20 06 FF FF FF FF FF FF FF FF FF FF FF  
1b 25 01  
20 20 0D 0A  
1b 3f 20  
30 20 30 20 0d 0a

②y = 3  
1B 40  
1b 26 03 20 20 06 FF FF FF FF FF FF FF FF FF FF FF FF FF FF FF  
1b 25 01  
20 20 0D 0A  
1b 3f 20  
30 20 30 20 0d 0a

### Cancel user customized characters

Name	Cancel user customized characters
Code	ASCII : ESC ? n DEC : 27 63 n HEX : 1B 3F n
Function	Cancel user customized characters of specified code by n
Range	32 ≤ n ≤ 126
Default	None



凱 勝 諾

# 厦门凯胜诺科技有限公司

## XIAMEN CASHINO TECHNOLOGY CO.,LTD.

F,No.322 of 109 ,Tongji South Road,Jimei District,Xiamen,China.361021 ( Zongshun Business Building)  
Tel:+86-0592-5517253 Fax:+86-0592-5213815 E-mail:sales@csntek.com

Notes	<p>This command terminates the use of styles defined for character encoding, which is specified by n. After the user customized character is canceled, it is printed in the corresponding mode of the internal character.</p> <p>In the font selected with ESC !, the command removes the style defined for the specified encoding.</p> <p>If a user customized character is not defined, the printer ignores the command.</p>
Example	None

### Set / remove quadruple angle of Chinese print

Name	Set / remove quadruple angle of Chinese print
Code	ASCII : FS W n DEC : 28 87 n HEX : 1C 57 n
Function	Set or remove quadruple angle of Chinese print When LSB of n is 0,Remove quadruple angle of character mode When LSB of n is 1,Set quadruple angle of character mode
Range	$0 \leq n \leq 255$
Default	n=0
Notes	<p>Only the lowest bit of n is valid;</p> <p>In quadruple angle mode,printing character size is the same as set double width and double height mode to print character size at the same time</p> <p>When the quadruple angle mode is canceled with this command,the characters are printed according to the size of the pass-through character;</p> <p>When the height of some characters in a line is different, all the characters in the line are aligned on the basis of the baseline;</p> <p>When the character is enlarged in the horizontal direction, the character is enlarged to the right with the left side of the character as the reference.</p>
Example	None

### Set the Angle of Chinese character word space

Name	Set the Angle of Chinese character word space
Code	ASCII : FS S n1 n2 DEC : 28 83 n1 n2 HEX : 1C 53 n1 n2
Function	Set the left and right Chinese character space to n1 and n2 respectively. The left character space is [n1*0.125 mm], and the right character space is [n2*0.125 mm]
Range	$0 \leq n1 \leq 255$ $0 \leq n2 \leq 255$
Default	n1=0,n2=0
Notes	This command sets the left and right character space of the variable size





凱 勝 諾

# 厦门凯胜诺科技有限公司

## XIAMEN CASHINO TECHNOLOGY CO.,LTD.

F, No. 322 of 109, Tongji South Road, Jimei District, Xiamen, China. 361021 ( Zongshun Business Building)  
Tel: +86-0592-5517253 Fax: +86-0592-5213815 E-mail: sales@csntek.com

	characters. When set to double width mode, the left and right character space is twice of the normal mode. You can set the space separately in standard mode. In standard mode, use horizontal motion units
Example	None

### Set up the Chinese characters to print mode combination

Name	Set up the Chinese characters to print mode combination				
Code	ASCII : FS ! n DEC : 28 33 n HEX : 1C 21 n				
Function	Set up Chinese characters print mode, the setting of n as follows:				
	Bit	OFF/ON	HEX	DEC	ASB status
	0	--	--	--	None
	1	--	--	--	None
	2	OFF	00	0	Double-width mode is forbidden
		ON	04	4	Allow Double-height mode
	3	OFF	00	0	Double-height mode is forbidden
		ON	08	8	Allow Double-height mode
	4	--	--	--	None
	5	--	--	--	None
6	--	--	--	None	
7	OFF	00	0	Underline mode is forbidden	
	ON	80	128	Allow the underline mode	
Range	0 ≤ n ≤ 255				
Default	n=0				
Notes	Setting both double width mode and double height mode ,(including the right and left character space),it will print out character in four times of the size. The printer can underline all characters (including the right and left character space), but not the spaces set by the HT command, and clockwise 90° rotation characters underlined; When some characters in a line are double height or higher, all characters in the line will be aligned along the baseline; The width of the underline is specified by FS – regardless of the character size;				
Example	None				

### Set Chinese mode

Name	Set Chinese mode
Code	ASCII : FS & DEC : 28 38 HEX: 1C 26



凱 勝 諾

# 厦门凯胜诺科技有限公司

XIAMEN CASHINO TECHNOLOGY CO.,LTD.

F,No.322 of 109 ,Tongji South Road,Jimei District,Xiamen,China.361021 ( Zongshun Business Building)  
Tel:+86-0592-5517253 Fax:+86-0592-5213815 E-mail:sales@csntek.com

Function	Set Chinese mode
Range	None
Default	None
Notes	When the Chinese character mode is selected, the printer processes all Chinese character codes(ASCII code) , two bytes at a time. The Chinese character code(ASCII code) is processed in the order of the first byte and the second byte.
Example	1b 40 1C 26 B0 AE C9 CF D7 D4 BC BA 0d 0a 1C 2E B0 AE C9 CF D7 D4 BC BA 0d 0a

## Exit Chinese character mode

Name	Exit Chinese character mode
Code	ASCII: FS . DEC : 28 46 HEX: 1C 2E
Function	Exit Chinese character mode, cancel Chinese character mode
Range	None
Default	None
Notes	None
Example	None

## Set and cancel under line of Chinese character mode

Name	Set and cancel under line of Chinese character mode								
Code	ASCII : FS – n DEC : 28 45 n HEX: 1C 2D n								
Function	Set/cancel underline mode,based on n value as below: <table border="1" style="margin-left: 20px;"> <thead> <tr> <th>n</th> <th>Function</th> </tr> </thead> <tbody> <tr> <td>0,48</td> <td>Cancel underline mode</td> </tr> <tr> <td>1,49</td> <td>Set underline mode(1dotcoarse)</td> </tr> <tr> <td>2,50</td> <td>Set underline mode(2dotcoarse)</td> </tr> </tbody> </table>	n	Function	0,48	Cancel underline mode	1,49	Set underline mode(1dotcoarse)	2,50	Set underline mode(2dotcoarse)
n	Function								
0,48	Cancel underline mode								
1,49	Set underline mode(1dotcoarse)								
2,50	Set underline mode(2dotcoarse)								
Range	$0 \leq n \leq 2, 48 \leq n \leq 50$								
Default	n=0								
Notes	Printer can print underline for all characters(including characters space in left and right),but expect for setted blank by HT and Clockwise 90° rotation character underlined; Setting n to 0, after cancel under line of Chinese character, the underline printing will not be performed, but the previously specified underline width remains unchanged. The default underline width is 1 dot.t The specified slip line width remains the same even if the character size had changed								



凱 勝 諾

廈門凱勝諾科技有限公司

XIAMEN CASHINO TECHNOLOGY CO.,LTD.

F,No.322 of 109 ,Tongji South Road,Jimei District,Xiamen,China.361021 ( Zongshun Business Building)  
Tel:+86-0592-5517253 Fax:+86-0592-5213815 E-mail:sales@csntek.com

Example	None
---------	------

### Selecting international character set

Name	Selecting international character set																																		
Code	ASCII : ESC R n DEC : 27 82 n HEX: 1B 52 n																																		
Function	Selecting international character set n from the following table: <table style="margin-left: 40px;"> <tr><td>n</td><td>Character</td></tr> <tr><td>0</td><td>U.S.A</td></tr> <tr><td>1</td><td>France</td></tr> <tr><td>2</td><td>Germany</td></tr> <tr><td>3</td><td>U.K</td></tr> <tr><td>4</td><td>Denmark I</td></tr> <tr><td>5</td><td>Sweden</td></tr> <tr><td>6</td><td>Italy</td></tr> <tr><td>7</td><td>Spain I</td></tr> <tr><td>8</td><td>Japan</td></tr> <tr><td>9</td><td>Norway</td></tr> <tr><td>10</td><td>Denmark II</td></tr> <tr><td>11</td><td>Spain II</td></tr> <tr><td>12</td><td>Latin America</td></tr> <tr><td>13</td><td>Korea</td></tr> <tr><td>14</td><td>Slovenia</td></tr> <tr><td>15</td><td>China</td></tr> </table>	n	Character	0	U.S.A	1	France	2	Germany	3	U.K	4	Denmark I	5	Sweden	6	Italy	7	Spain I	8	Japan	9	Norway	10	Denmark II	11	Spain II	12	Latin America	13	Korea	14	Slovenia	15	China
n	Character																																		
0	U.S.A																																		
1	France																																		
2	Germany																																		
3	U.K																																		
4	Denmark I																																		
5	Sweden																																		
6	Italy																																		
7	Spain I																																		
8	Japan																																		
9	Norway																																		
10	Denmark II																																		
11	Spain II																																		
12	Latin America																																		
13	Korea																																		
14	Slovenia																																		
15	China																																		
Range	$0 \leq n \leq 15$																																		
Default	0																																		
Notes	None																																		
Example	1B 40 1B 52 00 20 21 22 23 24 25 26 27 28 29 2A 2B 2C 2D 2E 2F 30 31 32 33 34 35 36 37 38 39 3A 3B 3C 3D 3E 3F 40 41 42 43 44 45 46 47 48 49 4A 4B 4C 4D 4E 4F 50 51 52 53 54 55 56 57 58 59 60 6A 6B 6C 6D 6E 6F 70 71 72 73 74 75 76 78 79 7A 7B 7C 7D 7E 0D 0A																																		

### Select character code

Name	Select character code
Code	ASCII : ESC t n DEC : 27 116 n HEX : 1B 74 n
Function	Selects n from character code



# 厦门凯胜诺科技有限公司

XIAMEN CASHINO TECHNOLOGY CO.,LTD.

凱 勝 諾

F.No.322 of 109 ,Tongji South Road,Jimei District,Xiamen,China.361021 ( Zongshun Business Building)  
Tel:+86-0592-5517253 Fax:+86-0592-5213815 E-mail:sales@csntek.com

N	Code Page
0	CP437[U.S.A., Standard Europe]
1	KataKana
2	CP850 [Multilingual]
3	CP860 [Portuguese]
4	CP863 [Canadian-French]
5	CP865 [Nordic]
6	WCP1251 [Cyrillic]
7	CP866 Cyrilliec #2
8	MIK [Cyrillic /Bulgarian]
9	CP755 [East Europe, Latvian 2]
10	Iran
11	Reserve
12	Reserve
13	Reserve
14	Reserve
15	CP862 [Hebrew]
16	WCP1252 Latin I
17	WCP1253 [Greek]
18	CP852 [Latina 2]
19	CP858 Multilingual Latin I +Euro)
20	Iran II
21	Latvian
22	CP864 [Arabic]
23	ISO-8859-1 [West Europe]
24	CP737 [Greek]
25	WCP1257 [Baltic]
26	Thai
27	CP720[Arabic]
28	CP855
29	CP857[Turkish]
30	WCP1250[Central Europe]
31	CP775
32	WCP1254[Turkish]
33	WCP1255[Hebrew]
34	WCP1256[Arabic]
35	WCP1258[Vietnam]
36	ISO-8859-2[Latin 2]
37	ISO-8859-3[Latin 3]
38	ISO-8859-4[Baltic]
39	ISO-8859-5[Cyrillic]
40	ISO-8859-6[Arabic]



# 厦门凯胜诺科技有限公司

XIAMEN CASHINO TECHNOLOGY CO.,LTD.

凱 勝 諾

F,No.322 of 109 ,Tongji South Road,Jimei District,Xiamen,China.361021 ( Zongshun Business Building)  
Tel:+86-0592-5517253 Fax:+86-0592-5213815 E-mail:sales@csntek.com

	41 ISO-8859-7[Greek] 42 ISO-8859-8[Hebrew] 43 ISO-8859-9[Turkish] 44 ISO-8859-15 [Latin 9] 45 Thai2 46 CP856 47 Cp874  252 CP932 SHIFT_JIS 253 UNICODE UCS-2 254 BIG5 255 GBK
Range	$0 \leq n \leq 255$
Default	0
Notes	None
Example	1B 40 1C 2E 1B 74 00 80 81 82 83 84 85 86 87 88 89 8A 8B 8C 8D 8E 8F 90 91 92 93 94 95 96 97 98 9A 9B 9C 9D 9E 9F A0 A1 A2 A3 A4 A5 A6 A7 A8 A9 AA AB AC AD AE AF B0 B1 B2 B3 B4 B5 B6 B7 B8 B9 BA BB BC BD BE BF C0 C1 C2 C3 C4 C5 C6 C7 C8 C9 CA CB CC CD CE CF D0 D1 D2 D3 D4 D5 D6 D7 D8 D9 DA DB DC DD DE DF E0 E1 E2 E3 E4 E5 E6 E7 E8 E9 EA EB EC ED EE EF F0 F1 F2 F3 F4 F5 F6 F7 F8 F9 FA FB FC FD FE FF 0D 0A

### ③Graphic printing command

#### Fill Graphics vertical module data

Name	Fill Graphics vertical module data
Code	ASCII : ESC * m HI Hh [d]k DEC : 27 42 m HI Hh [d]k HEX : 1B 2A m HI Hh [d]k
Function	Print vertical module graphic data,the parameters as below: m is bit map format: m mode horizontal scale vertical scale 0 8dots single density ×2 ×3 1 8dots double density ×1 ×3 32 24dots single density ×2 ×1 33 24dots double density ×1 ×1 HI、Hh is horizontal direction dots(HI+256×Hh) [d]k is bit map data K used for indicating bit map data bytes,not for transfer.

Parameter range	<p>XX58:</p> <p><math>m=0、1、32、33</math>  <math>1 \leq Hl + Hh \times 256 \leq 384</math>  <math>0 \leq d \leq 255</math>  <math>k = Hl + Hh \times 256</math> (when <math>m=0、1</math>)  <math>k = (Hl + Hh \times 256) \times 3</math> (when <math>m=32、33</math>)</p> <p>XX80:</p> <p><math>m=0、1、32、33</math>  <math>1 \leq Hl + Hh \times 256 \leq 576</math>  <math>0 \leq d \leq 255</math>  <math>k = Hl + Hh \times 256</math> (when <math>m=0、1</math>)  <math>k = (Hl + Hh \times 256) \times 3</math> (when <math>m=32、33</math>)</p>
Default	None
Notes	<p>[d]k corresponding bit is 1, which means that this bit can print. While it is 0, it means that this bit can not print.</p> <p>The part of graphics horizontal direction which exceeds the printing area will be ignored.</p> <p>The relations between Bit map data and printing effects is as below:</p> <div style="text-align: center;"> </div> <p>The command fills only the printing buffer, graphics printing can start only after receiving the printing commands. Printing buffer will be cleared after graphic printing.</p> <p>If you need to print higher graphics, you can divide it into several sections which has 8 (<math>m = 0、1</math>) or 24 (<math>m = 32、33</math>) dots graphics to print.</p> <p>After filling graphic data, you can continue to fill other information to make graphic and other information print simultaneously.</p> <p>After filling bitmap, you can use ESC J(<math>n=24</math>) command to print, and also can use LF command to print. But using LF command will cause paper feeding (feeding paper according to the line space), and make graphic continuous between different lines. And can set line space as 0 to avoid feeding too much. (Dot matrix printer may drift when it starts, pls send data continuously if occurs line broken).</p>
Example	1B 40



凱 勝 諾

廈門凱勝諾科技有限公司

XIAMEN CASHINO TECHNOLOGY CO.,LTD.

F,No.322 of 109 ,Tongji South Road,Jimei District,Xiamen,China.361021 ( Zongshun Business Building)  
Tel:+86-0592-5517253 Fax:+86-0592-5213815 E-mail:sales@csntek.com

	1b 2a 00 0C 00 FF FF FF FF FF FF FF FF FF FF FF FF 1B 33 00 0A
--	--

### Print Graphics horizontal module data

Name	Print Graphics horizontal module data																				
Code	ASCII : GS v 0 DEC : 29 118 48 m xL xH yL yH [d]k HEX : 1D 76 30 m xL xH yL yH [d]k																				
Function	<p>Print horizontal module graphic data,the parameters as below: m as bitmap method:</p> <table border="1"> <thead> <tr> <th>m</th> <th>Model</th> <th>Horizontal scale</th> <th>Vertical scale</th> </tr> </thead> <tbody> <tr> <td>0,48</td> <td>Normal</td> <td>× 1</td> <td>× 1</td> </tr> <tr> <td>1,49</td> <td>Double-width</td> <td>× 2</td> <td>× 1</td> </tr> <tr> <td>2,50</td> <td>Double-height</td> <td>× 1</td> <td>× 2</td> </tr> <tr> <td>3,51</td> <td>Quadruple</td> <td>× 2</td> <td>× 2</td> </tr> </tbody> </table> <p>xL、xH were selected as the data bytes (xL+xH×256) in the horizontal direction for the bitmap. yL, yH were selected as the data bytes(yL+yH×256) in the vertical direction for the bitmap. [d]k for bitmap data k for bitmap data bytes, k used for indicating, not for transfer.</p>	m	Model	Horizontal scale	Vertical scale	0,48	Normal	× 1	× 1	1,49	Double-width	× 2	× 1	2,50	Double-height	× 1	× 2	3,51	Quadruple	× 2	× 2
m	Model	Horizontal scale	Vertical scale																		
0,48	Normal	× 1	× 1																		
1,49	Double-width	× 2	× 1																		
2,50	Double-height	× 1	× 2																		
3,51	Quadruple	× 2	× 2																		
Parameter range	<p>XX58:  <math>0 \leq m \leq 3; 48 \leq m \leq 51</math>  <math>1 \leq xL + xH \times 256 \leq 48</math>  <math>0 \leq yL \leq 255, 0 \leq yH \leq 255</math>  <math>0 \leq d \leq 255</math>  <math>k = (Hl + Hh \times 256) \times (yL + yH \times 256)</math></p> <p>XX80:  <math>0 \leq m \leq 3; 48 \leq m \leq 51</math>  <math>1 \leq xL + xH \times 256 \leq 72</math>  <math>0 \leq yL \leq 255, 0 \leq yH \leq 255</math>  <math>0 \leq d \leq 255</math>  <math>k = (Hl + Hh \times 256) \times (yL + yH \times 256)</math></p>																				
Default	None																				
Notes	<p>[d] k corresponding bit is 1,which means that this bit can print.While it is 0,it means that this bit can not print. If the horizontal bytes exceed printing area, then the exceeding part will be ignored. The paper feeds accordingly to the image size when this commanding is using, not influenced by the setting of ESC 2, ESC 3 line space.</p>																				

	<p>After this command, the printing coordinates will be reset to the left margin and the image content will be cleared.          the relationship between bitmap data and the printing effect is as below:</p> <table border="1" style="margin-left: auto; margin-right: auto;"> <tr> <td>d1</td> <td>d2</td> <td>.....</td> <td>dx</td> </tr> <tr> <td>d(x+1)</td> <td>d(x+2)</td> <td>.....</td> <td>d(x+2)</td> </tr> <tr> <td> </td> <td> </td> <td>.....</td> <td> </td> </tr> <tr> <td>.....</td> <td>d(k-2)</td> <td>d(k-1)</td> <td>dk</td> </tr> </table> <p style="text-align: center;">MSB    LSB   MSB    LSB   MSB    LSB   MSB    LSB</p> <p>This command has the printing function, data will be transferred while printing, no need to use the printing command again</p>	d1	d2	.....	dx	d(x+1)	d(x+2)	.....	d(x+2)			.....		.....	d(k-2)	d(k-1)	dk
d1	d2	.....	dx														
d(x+1)	d(x+2)	.....	d(x+2)														
		.....															
.....	d(k-2)	d(k-1)	dk														
Example	<pre>1B 40 1d 76 30 00 03 00 09 00 FF</pre>																

### Define downloaded bitmap

Name	Define downloaded bitmap
Code	ASCII : GS * x y d1...d(x*y*8) DEC : 29 42 x y d1 ...d(x*y*8) HEX : 1D 2A x y d1...d(x*y*8)
Function	using x and y to appoint dots to define the downloaded bitmap x appoints that the horizontal dots as 8*x. y appoints that the vertical dots as 8*y.
Parameter range	$1 \leq x \leq 255$ $1 \leq y \leq 48$ $x*y \leq 1536$ $0 \leq d \leq 255$
Default	None
Notes	<p>If x*y is out of the specified range, this command will be forbidden.          The d indicates bitmap data. Data (d) specifies the printing bit as 1 and the not printing bit as 0.          The downloaded bitmap definition will be cleared when:          ESC @ is executed.          ESC &amp; is executed.          Printer is reset or the power is turned off.</p> <p>The following figure shows the relationship between the downloaded bitmap and the printed data</p>



Example	<pre> 1B 40 1D 2A 03 03 FF 1D 2F 00                     </pre>

### Print downloaded bitmap

Name	Print downloaded bitmap										
Code	ASCII : GS / m DEC : 29 47 m HEX : 1D 2F m										
Function	Prints a downloaded bitmap using the mode specified by m. Using the mode that m appointed to print downloaded bitmap <table border="1" style="margin-left: 20px;"> <thead> <tr> <th>m</th> <th>Model</th> </tr> </thead> <tbody> <tr> <td>0, 48</td> <td>Normal</td> </tr> <tr> <td>1, 49</td> <td>Double-width</td> </tr> <tr> <td>2, 50</td> <td>Double-height</td> </tr> <tr> <td>3, 51</td> <td>Quadruple</td> </tr> </tbody> </table>	m	Model	0, 48	Normal	1, 49	Double-width	2, 50	Double-height	3, 51	Quadruple
m	Model										
0, 48	Normal										
1, 49	Double-width										
2, 50	Double-height										
3, 51	Quadruple										
Parameter range	$0 \leq m \leq 3$ $48 \leq m \leq 51$										
Default	None										



凱 勝 諾

# 厦门凯胜诺科技有限公司

XIAMEN CASHINO TECHNOLOGY CO.,LTD.

F.No.322 of 109 ,Tongji South Road,Jimei District,Xiamen,China.361021 ( Zongshun Business Building)  
Tel:+86-0592-5517253 Fax:+86-0592-5213815 E-mail:sales@csntek.com

Notes	<p>This command will be ignored if the bitmap data has not been defined.</p> <p>In standard mode, this command is effective only when there is no data in the buffer area.</p> <p>This command has no effect in the print modes (emphasized, double-strike, downloaded line, character size, or white/black reverse printing), except for upside down printing mode.</p> <p>If the downloaded bitmap which will be printed exceeds the printing area, then the excess data will not be printed.</p>
Example	No

## Define NV bitmap

Name	Define NV bitmap
Code	<p>ASCII : FS q n [xL xH yL yH d1...dk]1...[xL xH yL yH d1...dk]n</p> <p>DEC : 28 113 n [xL xH yL yH d1...dk]1...[xL xH yL yH d1...dk]n</p> <p>HEX : 1C 71 n [xL xH yL yH d1...dk]1...[xL xH yL yH d1...dk]n</p>
Function	<p>Define the NV bitmap using the specified n.</p> <p>n specifies the number of the defined NV bitmap.</p> <p>xL, xH means that the defined NV bitmap specifies the horizontal dots as <math>(xL+xH*256)*8</math></p> <p>yL, yH means that the defined NV bitmap specifies the vertical dots as <math>(yL + yH*256)*8</math></p>
Parameter range	<p><math>1 \leq n \leq 255</math></p> <p><math>0 \leq xL \leq 255</math></p> <p><math>0 \leq xH \leq 3</math></p> <p><math>(1 \leq (xL+xH*256) \leq 1023)</math></p> <p><math>0 \leq yL \leq 255</math></p> <p><math>0 \leq yH \leq 1</math></p> <p><math>(1 \leq (yL+yH*256) \leq 288)</math></p> <p><math>0 \leq d \leq 255</math></p> <p><math>k = (xL+xH*256)*(yL+yH*256)*8</math></p> <p>Totalled the defined data Area = 64 k bytes</p>
Default	None
Support Model	All
Notes	<p>Frequent writing command executions may damage the NV memory. Therefore, it is recommended to write the NV memory no more than 10 times per day.</p> <p>The printer performs a hardware reset operation after the procedure of placing the image into the NV memory. Therefore, user-defined characters, downloaded bitmaps should be defined only after completing this command. The printer clears</p>



凱 勝 諾

# 厦门凯胜诺科技有限公司

XIAMEN CASHINO TECHNOLOGY CO.,LTD.

F,No.322 of 109 ,Tongji South Road,Jimei District,Xiamen,China.361021 ( Zongshun Business Building)  
Tel:+86-0592-5517253 Fax:+86-0592-5213815 E-mail:sales@csntek.com

the receiving and printing buffers and resets the printer to the mode that workable when power on. (hardware reset interface is not supported )

This command cancels all NV bitmaps that have already been defined by this command.

From the beginning of the processing of this command till the accomplishment of hardware reset, mechanical operations (including initializing the position of the print head when the cover is open, paper feeding using the FEED button, etc.) cannot be performed.

During this command processing, the printer is busy and stops receiving data when writing data to the user's NV memory. Therefore, data transmission, including real-time commands, is prohibited during the execution of this command.

NV bitmap is a bitmap defined in non-volatile memory, Define FS p printing with FS q.

In standard mode, this command is valid only when processed at the beginning of the line.

This command is valid when 7 bytes <FS yH> of the command are processed normally.

When the data volume exceeds the left capacity of the range defined by xL, xH, yL, and yH, the printer will process the range defined by xL, xH, yL, and yH outside the defined range.

In the first group of NV bitmaps, when any one of xL, xH, yL, yH is out of the definition range, this command is disabled.

In groups of NV bitmaps other than the first group, when xL, xH, yL, yH out of the defined range, it stops processing this command and starts writing into the NV images. At this time, NV bitmaps that haven't been defined are disabled (undefined), but any NV bitmaps before that are enabled.

The d indicates the definition data. In data (d) a 1 bit specifies a dot to be printed and a 0 bit specifies a dot not to be printed.

This command defines n as the number of a NV bitmap. Numbers rise in order from NV bitmap 01H. Therefore, the first data group [xL xH yL yH d1...dk] is NV bitmap 01H, and the last data group [xL xH yL yH d1...dk] is NV bitmap n. The total agrees with the number of NV bitmaps specified by the command FS p.

The definition data for an NV bitmap consists of [xL xH yL yH d1...dk]. Therefore, when only one NV bitmap is defined n=1, the printer processes a data group [xL xH yL yH d1...dk] once. The printer uses ([data: (xL xH× 256)×(yL yH× 256)×8] [header :4]) bytes of NV memory.

The definition area in this printer is a maximum of 192K bytes. This command can define several NV bitmaps, but cannot define bitmap data whose total capacity [bitmap data header] exceeds 192K bytes.

The printer does not transmit ASB status or perform status detection during processing of this command even when ASB is specified.

Once an NV bitmap is defined, it is not erased by performing ESC @, reset, and power off.

This command performs only definition of an NV bitmap and does not perform printing. Printing of the NV bitmap is performed by the FS p command.

Diagram: when  $xL = 64$ ,  $xH = 0$ ,  $yL = 96$ ,  $yH = 0$

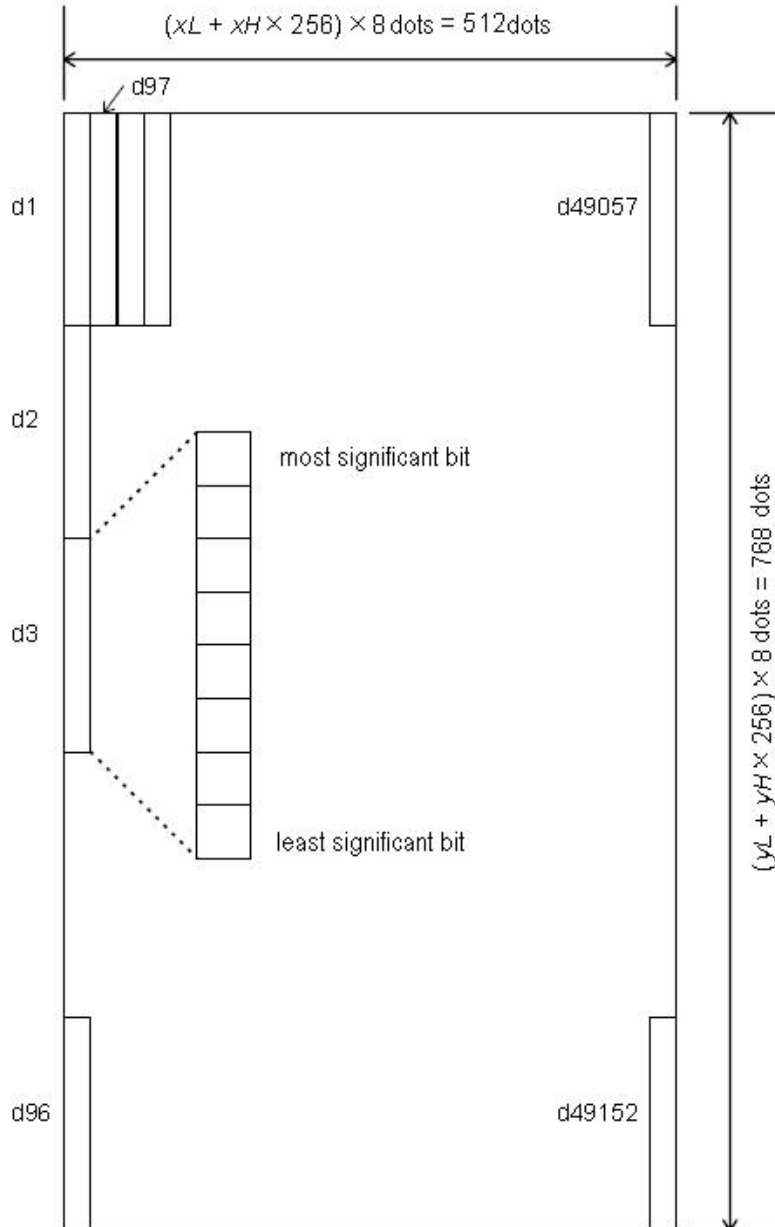

Example

```
1B 40
1C 71 01 03 00 03 00
FF FF FF FF FF FF FF FF FF FF FF FF FF FF FF FF FF FF FF FF FF FF FF FF FF
FF FF FF FF FF FF FF FF FF FF FF FF FF FF FF FF FF FF FF FF FF FF FF FF FF
```



凱 勝 諾

# 厦门凯胜诺科技有限公司

## XIAMEN CASHINO TECHNOLOGY CO.,LTD.

F,No.322 of 109 ,Tongji South Road,Jimei District,Xiamen,China.361021 ( Zongshun Business Building)  
Tel:+86-0592-5517253 Fax:+86-0592-5213815 E-mail:sales@csntek.com

	FF 1C 70 01 00
--	--

### Print NV bitmap

Name	Print NV bitmap										
Code	ASCII : FS p n m DEC : 28 112 n m HEX : 1C 70 n m										
Function	Print NV bitmap n using the mode specified by m. <table border="1" style="margin-left: 20px;"> <thead> <tr> <th>m</th> <th>Mode</th> </tr> </thead> <tbody> <tr> <td>0, 48</td> <td>Normal</td> </tr> <tr> <td>1, 49</td> <td>Double-width</td> </tr> <tr> <td>2, 50</td> <td>Double-height</td> </tr> <tr> <td>3, 51</td> <td>Quadruple</td> </tr> </tbody> </table>	m	Mode	0, 48	Normal	1, 49	Double-width	2, 50	Double-height	3, 51	Quadruple
m	Mode										
0, 48	Normal										
1, 49	Double-width										
2, 50	Double-height										
3, 51	Quadruple										
Parameter range	$0 \leq m \leq 3$ $48 \leq m \leq 51$ $1 \leq n \leq 255$										
Default	None										
Support	All										
Notes	<p>n is the number of the NV bitmap (defined using the FS q command). m specifies the bitmap mode. NV bitmap is a bitmap defined in non-volatile memory by FS q and printed by FS p. This command is not effective when the specified NV bitmap has not been defined. In standard mode, this command is effective only when there is no data in the print buffer.</p> <p>This command is not affected by print modes (Bold printing, overlapping,underline, character size, white/black reverse printing, or 90°rotated characters, etc.), except upside-down printing mode.</p> <p>If the downloaded bit-image to be printed exceeds one line, the excess data is not printed.</p> <p>This command feeds dots (for the height n of the NV bitmap) in normal and double-width modes, and (for the height <math>n/2</math> of the NV bitmap) in doubleheight and quadruple modes, regardless of the line space specified by ESC 2 or ESC 3.</p> <p>After printing the bitmap, this command sets the print position to the beginning of the line and processes the data that follows as normal data.</p>										
Example	None										



凱 勝 諾

厦门凯胜诺科技有限公司

XIAMEN CASHINO TECHNOLOGY CO.,LTD.

F,No.322 of 109 ,Tongji South Road,Jimei District,Xiamen,China.361021 ( Zongshun Business Building)  
Tel:+86-0592-5517253 Fax:+86-0592-5213815 E-mail:sales@csntek.com

## ④ Tab Commands

### Horizontal tab

Name	Horizontal tab
Code	ASCII : HT DEC : 9 HEX : 09
FUNCTION	Move the print position to the next tab position
Parameter range	None
Defaults	None
Notes	Tab position set by ESC D If the tab position is not set(the default is no horizontal position),this command will be treated as an LF command If the tab position exceeds the print area,the coordinates will move to the star position of the next line(as the data is full,print and wrap)
Example	none

### Horizontal tab position setting

Name	horizontal tab position setting
Code	ASCII : ESC D [d]k NUL DEC : 27 68 [d]k 0 HEX : 1B 44 [d]k 00
Function	Set horizontal tab position, parameter meaning as below: d1 ... dk: horizontal position,in 8 as unit,null as the terminator
Parameter range	XX58: $1 \leq d \leq 46$ ( $d_1 < d_2 < \dots < d_k$ , $1 \leq k \leq 16$ ) XX80: $1 \leq d \leq 70$ ( $d_1 < d_2 < \dots < d_k$ , $1 \leq k \leq 16$ )
Defaults	The default positioning position is the 8-character interval(Column 9 17 25...) of the font A(12-24)
Support model	All
Notes	Tab position as below:

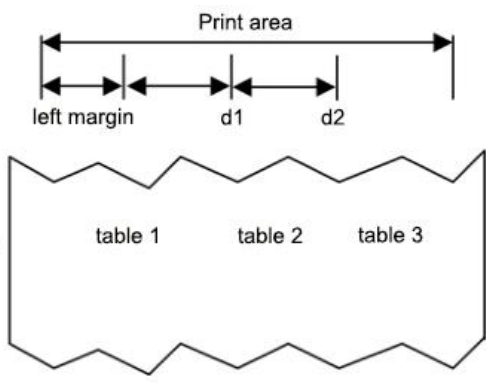

	<div style="text-align: center;">  </div> <p>TAB position d1 and d2 setting</p> <p>Maximum support for the setting of 16 tab position</p> <p>Using this command,the setting of previous tab position will be canceled</p> <p>k is for indication purpose,no transmission</p> <p>When transport [d]k,and come across NULL,should be considered over</p> <p>If dk less than or equal to dk-1,should be considered over,and balance data is treated as normal data processing</p> <p>TAB position could be changed by HT command</p> <p>When the left margin changes, the TAB position changes simultaneously</p> <p>The command setting will be valid after ESC @、 printer reset、 power off</p>
Example	1B 44 04 06 08 0A 00 09 30 09 31 09 32 09 33 0D 0A

### ⑤One-dimension bar code command



#### 1D bar code readable character(HRI) print position setting

Name	1D bar code readable character(HRI)print position setting
Code	ASCII : GS H n DEC : 29 72 n HEX : 1D 48 n
Function	Set 1D bar code readable character(HRI)print position,n parameter meaning as below: n print position 0, 48 don't print 1, 49 above the bar code 2, 50 below the bar code 3, 51 above and below the bar code
Parameter range	$0 \leq n \leq 3$ or $48 \leq n \leq 51$
Defaults	n = 0
Notes	The command setting will be valid after ESC @、 printer reset、 power off
Example	None

### 1D bar code height setting

Name	1D bar code height setting
Code	ASCII : GS h n DEC : 29 104 n DEX : 1D 68 n
Function	Parameter n specifies the height of a bar code in dots:  Height 50  Height 100
Parameter range	$1 \leq n \leq 255$
Defaults	n = 64
Notes	The command setting will be valid after ESC @、 printer reset、 power off
Example	None

### 1D bar code width setting

Name	1D bar code width setting
Code	ASCII : GS w n DEC : 29 119 n HEX : 1D 77 n
Function	Parameter n specifies the unit of a bar code in dots:  Width 3  Width 4
Parameter range	$1 \leq n \leq 6$
Defaults	n = 2
Noted	The command setting will be valid after ESC @、 printer reset、 power off
Example	None

### 1D bar code printing

Name	1D bar code printing
------	----------------------





# 厦门凯胜诺科技有限公司

XIAMEN CASHINO TECHNOLOGY CO.,LTD.

凱 勝 諾

F.No.322 of 109 ,Tongji South Road,Jimei District,Xiamen,China.361021 ( Zongshun Business Building)  
Tel:+86-0592-5517253 Fax:+86-0592-5213815 E-mail:sales@csntek.com

Code	<p>(A) ASCII : GS k m [d]k NUL DEC : 29 107 m [d]k NUL Hex : 1D 6B m [d]k NUL</p> <p>(B) ASCII : GS k m n [d]k DEC : 29 107 m n [d]k Hex : 1D 6B m n [d]k</p>																																																								
Function	<p>1D bar code printing,the parameters meaning as below: m is encoding n is code data length,only for (command B),the difference between (A) and (B)is that the data (A) end with NULL,but (B) indicates the data length [d]k is bar code data K is the length of the bar code data,for sign,no transmission Parameters relationship as below: <b>(Command A)</b></p> <table border="1"> <thead> <tr> <th rowspan="2">m</th> <th rowspan="2">Coding system</th> <th colspan="4">Bar code length ( SP show space )</th> </tr> <tr> <th>Data length</th> <th>k</th> <th>Character set</th> <th>Data (d)</th> </tr> </thead> <tbody> <tr> <td>0</td> <td>UPC-A</td> <td>fixed</td> <td>k = 11, 12</td> <td>0~9</td> <td>48≤d≤57</td> </tr> <tr> <td>1</td> <td>UPC-E</td> <td>fixed</td> <td>6≤k≤8, k = 11, 12</td> <td>0~9</td> <td>48≤d≤57 [when k = 7,8,11,12, d1 = 48 ]</td> </tr> <tr> <td>2</td> <td>JAN13 (EAN13)</td> <td>fixed</td> <td>k = 12, 13</td> <td>0~9</td> <td>48≤d≤57</td> </tr> <tr> <td>3</td> <td>JAN8 (EAN8)</td> <td>fixed</td> <td>k = 7, 8</td> <td>0~9</td> <td>48≤d≤57</td> </tr> <tr> <td>4</td> <td>CODE39</td> <td>changeable</td> <td>1≤k</td> <td>0~9, A~Z SP, \$, %, *, +, -, ., /</td> <td>48≤d≤57, 65≤d≤90, d = 32, 36, 37, 42, 43, 45, 46, 47</td> </tr> <tr> <td>5</td> <td>ITF (Interleaved 2 of 5)</td> <td>changeable</td> <td>2≤k≤255 (even numbers)</td> <td>0~9</td> <td>48≤d≤57</td> </tr> <tr> <td>6</td> <td>CODAB AR (NW-7)</td> <td>changeable</td> <td>1≤k</td> <td>0~9, A~D, a~d \$, +, -, ., /, :</td> <td>48≤d≤57, 65≤d≤68, 97≤d≤100, d = 36, 43, 45, 46, 47, 58 (65≤d1≤68, 65≤dk≤68, 97≤d1≤100,</td> </tr> </tbody> </table>					m	Coding system	Bar code length ( SP show space )				Data length	k	Character set	Data (d)	0	UPC-A	fixed	k = 11, 12	0~9	48≤d≤57	1	UPC-E	fixed	6≤k≤8, k = 11, 12	0~9	48≤d≤57 [when k = 7,8,11,12, d1 = 48 ]	2	JAN13 (EAN13)	fixed	k = 12, 13	0~9	48≤d≤57	3	JAN8 (EAN8)	fixed	k = 7, 8	0~9	48≤d≤57	4	CODE39	changeable	1≤k	0~9, A~Z SP, \$, %, *, +, -, ., /	48≤d≤57, 65≤d≤90, d = 32, 36, 37, 42, 43, 45, 46, 47	5	ITF (Interleaved 2 of 5)	changeable	2≤k≤255 (even numbers)	0~9	48≤d≤57	6	CODAB AR (NW-7)	changeable	1≤k	0~9, A~D, a~d \$, +, -, ., /, :	48≤d≤57, 65≤d≤68, 97≤d≤100, d = 36, 43, 45, 46, 47, 58 (65≤d1≤68, 65≤dk≤68, 97≤d1≤100,
m	Coding system	Bar code length ( SP show space )																																																							
		Data length	k	Character set	Data (d)																																																				
0	UPC-A	fixed	k = 11, 12	0~9	48≤d≤57																																																				
1	UPC-E	fixed	6≤k≤8, k = 11, 12	0~9	48≤d≤57 [when k = 7,8,11,12, d1 = 48 ]																																																				
2	JAN13 (EAN13)	fixed	k = 12, 13	0~9	48≤d≤57																																																				
3	JAN8 (EAN8)	fixed	k = 7, 8	0~9	48≤d≤57																																																				
4	CODE39	changeable	1≤k	0~9, A~Z SP, \$, %, *, +, -, ., /	48≤d≤57, 65≤d≤90, d = 32, 36, 37, 42, 43, 45, 46, 47																																																				
5	ITF (Interleaved 2 of 5)	changeable	2≤k≤255 (even numbers)	0~9	48≤d≤57																																																				
6	CODAB AR (NW-7)	changeable	1≤k	0~9, A~D, a~d \$, +, -, ., /, :	48≤d≤57, 65≤d≤68, 97≤d≤100, d = 36, 43, 45, 46, 47, 58 (65≤d1≤68, 65≤dk≤68, 97≤d1≤100,																																																				



# 厦门凯胜诺科技有限公司

XIAMEN CASHINO TECHNOLOGY CO.,LTD.

凱 勝 諾

F.No.322 of 109 ,Tongji South Road ,Jimei District,Xiamen,China.361021 ( Zongshun Business Building)  
Tel:+86-0592-5517253 Fax:+86-0592-5213815 E-mail:sales@csntek.com

						97≤dk≤100)
<b>(Command B)</b>						
m	Coding system	Bar code length ( SP show space )				
		Data length	n	Character set	Data ( d )	
65	UPC-A	fixed	n = 11, 12	0~9	48≤d≤57	
66	UPC-E	fixed	6≤n≤8, n = 11, 12	0~9	48≤d≤57 [when n = 7,8,11,12, d1 = 48 ]	
67	JAN13 (EAN13)	fixed	n = 12, 13	0~9	48≤d≤57	
68	JAN8 (EAN8)	fixed	n = 7, 8	0~9	48≤d≤57	
69	CODE39	changeable	1≤n	0~9, A~Z SP, \$, %, *, +, -, ., /	48≤d≤57, 65≤d≤90, d = 32, 36, 37, 42, 43, 45, 46, 47	
70	ITF (Interleaved 2 of 5)	changeable	2≤n≤255 (even numbers)	0~9	48≤d≤57	
71	CODABAR (NW-7)	changeable	1≤n	0~9, A~D, a~d \$, +, -, ., /, :	48≤d≤57, 65≤d≤68, 97≤d≤100, d = 36, 43, 45, 46, 47, 58 (65≤d1≤68, 65≤dk≤68, 97≤d1≤100, 97≤dk≤100)	
72	CODE93	changeable	1≤n≤255	00H~7FH	0≤d≤127	
73	CODE128	changeable	1≤n≤255	00H~7FH C1H~C4H(FN C)	0≤d≤127 d = 193, 194,195,196	
74	UCC/EA	cha	1≤n≤255	00H~7FH	0≤d≤127	



凱 勝 諾

# 厦门凯胜诺科技有限公司

## XIAMEN CASHINO TECHNOLOGY CO.,LTD.

F.No.322 of 109 ,Tongji South Road,Jimei District,Xiamen,China.361021 ( Zongshun Business Building)  
Tel:+86-0592-5517253 Fax:+86-0592-5213815 E-mail:sales@csntek.com

	N128	ng e a b l e		C1H~C4H(FN C)	d = 193, 194,195,196
Parameter range	(A) $0 \leq m \leq 6$ (B) $65 \leq m \leq 74$				
Defaults	None				
Notes	<p>If the bar code width exceed the printable area,the printer does not perform barcode printing</p> <p>Paper feed as needed when the command is carried out,that not affected by ESC2,ESC3 line space settings,and do not influence line space settings The command is not affected by ESC ! character style setting</p> <p>The print position is resorted to the print start location after the command is executed</p> <p>m parameter 0 ~ 6(A) and 65 ~ 71(B) select the same coding system,the same printing effect</p> <p>m parameter is 0 ~ 6(A),barcode data end with NULL</p> <p>m parameter is 65 ~ 74(B),barcode data n stand for data length</p> <p>K is for sign,no transmission</p> <p>When print UPCA (m = 0 or 65) ,Please pay attention for the following points:          Whatever the input data length is 11 or 12,the check bit is automatically inserted or corrected          Initial character,central split character,and terminator are inserted automatically</p> <p>When print UPCE (m = 1 or 66) ,Please pay attention as following:          The system character (NSC) 0 will be inserted automatically when data length is 6          The first system character (NSC) d1 must be 0 when the data length is 7,8,11 and 12.          Whatever the data length is 6,7,8,11 and 12,the check bit inserted or corrected automatically</p> <p>Whatever the input data length is 6,7,8,11,and 12,the barcode readable character(HRI) just show 6 as data,but excluded system character (NSC) and check code;</p> <p>The transition relation between transmission and printing data as below:</p>				



# 厦门凯胜诺科技有限公司

XIAMEN CASHINO TECHNOLOGY CO.,LTD.

凱 勝 諾

F,No.322 of 109 ,Tongji South Road,Jimei District,Xiamen,China.361021 ( Zongshun Business Building)  
Tel:+86-0592-5517253 Fax:+86-0592-5213815 E-mail:sales@csntek.com

Transmitted data										Printed data					
d2	d3	d4	d5	d6	d7	d8	d9	d10	d11	d1	d2	d3	d4	d5	d6
0~9	0~9	0	0	0	-	-	0~9	0~9	0~9	d2	d3	d9	d10	d11	0
0~9	0~9	1	0	0	-	-	0~9	0~9	0~9	d2	d3	d9	d10	d11	1
0~9	0~9	2	0	0	-	-	0~9	0~9	0~9	d2	d3	d9	d10	d11	2
0~9	0~9	3~9	0	0	-	-	-	0~9	0~9	d2	d3	d4	d10	d11	3
0~9	0~9	0~9	1~9	0	-	-	-	-	0~9	d2	d3	d4	d5	d11	4
0~9	0~9	0~9	0~9	1~9	-	-	-	-	5~9	d2	d3	d4	d5	d6	d11

When d6 is 1~9,be sure d7,d8,d9,d10 are 0,and d11 is 5~9

Initial character,terminator automatically inserted

When print EAN13(m = 2 or 67),Please pay attention as following:

Whatever the input data length is 12 or 13,check bit is automatically inserted or corrected

Initial character,central split character and terminator inserted automatically

When print EAN8(m = 3 or 68),please pay attention as following:

Whatever input data length is 7 or 8,the check bit is automatically inserted or corrected

Initial character,central split character and terminator inserted automatically

When print CODE39(m = 4 or 69),please pay attention as following:

When d1 or dn are not Initial character/terminator "\*", encoder is automatically inserted "\*\*"

When middle of the data encounter "\*", the encoder regard it as terminator, the other data as the normal data;

The check bit could not calculate and add automatically

When print ITF25(m = 5 or 70), please pay attention as following:

Initial character and terminator inserted automatically

The check bit could not calculate and add automatically

When print CODABAR (NW-7) (m = 6 or 71),please pay attention as following:

Initial character and terminator could not inserted automatically,but manual addition by user, that the range from "A"~"D" or "a"~"d"

Check bit could not calculate and add automatically

When print CODE93(m = 72),please pay attention as following:

Initial character and terminator inserted automatically

The two check code are automatically calculated and then inserted

When barcode readable character(HRI) is set to print, there is no HRI character which indicating start/end



# 厦门凯胜诺科技有限公司

XIAMEN CASHINO TECHNOLOGY CO.,LTD.

凱 勝 諾

F, No.322 of 109, Tongji South Road, Jimei District, Xiamen, China. 361021 ( Zongshun Business Building)  
Tel: +86-0592-5517253 Fax: +86-0592-5213815 E-mail: sales@csntek.com

When barcode readable character(HRI) is set to print,the control character will be replaced with space

When print CODE128(m = 73),please pay attention as following:

The encoding system intelligently identifies data and implements minimum length encoding without the user set character (include starting character set) or switch character

Function character FNC1~FNC4 use C1H~C4H and input it

The check bit could calculate and add automatically

When barcode readable character(HRI) is set to print,the control character and FNC1~FNC4 will be replaced with space

When print EAN128(m = 74),please pay attention as following:

Basic construction as below:

Initial character set	FNC1	AI	Data part	Check bit A	Check bit B	Terminator
Inserted automatically		(d1...dk)			Inserted automatically	

Connection structure as below:

Initial character set	FNC1	AI	Data part	Check bit A	FNC1	AI	Data part	Check bit A	Check bit B	Terminator
Inserted automatically		(d1...dk)						Inserted automatically		

The encoding system intelligently identifies data and implements minimum length encoding without the user set character (include starting character set) or switch character

Function character FNC1~FNC4 use C1H~C4H and input it

User input data AI,which do not need “(”)” for indication,encoding system inserted automatically,otherwise it will be wrong.For example,GS k 74 18 "019501234567890\*", 01 is AI,the following will be wrong:GS k 74 18 "(01)9501234567890\*"

When user use the connection structure,need to insert FNC1(C1H"Decimal=193") in the middle.The input example as following:

GS k 74 18 "019501234567890\*" 193 "029501234567890\*"

When bar code readable character(HRI) is set to print,the control character will be replaced with space,then cancel FNC1~FNC4

Example	1b 40 1d 48 02 1d 6b 41 0c 31 32 33 34 35 36 37 38 39 30 31 32
---------	---



# 厦门凯胜诺科技有限公司

XIAMEN CASHINO TECHNOLOGY CO.,LTD.

凱 勝 諾

F.No.322 of 109 ,Tongji South Road,Jimei District,Xiamen,China.361021 ( Zongshun Business Building)  
Tel:+86-0592-5517253 Fax:+86-0592-5213815 E-mail:sales@csntek.com

1d 6b 42 0c 30 32 33 34 35 36 30 30 30 30 38 39
1d 6b 43 0c 30 32 33 34 35 36 30 30 30 30 38 39
1d 6b 44 08 30 32 33 34 35 36 30 30
1d 6b 45 08 30 32 33 34 35 36 30 30
1d 6b 46 08 30 32 33 34 35 36 30 30
1d 6b 47 08 41 32 33 34 35 36 30 41
1d 6b 48 08 41 30 32 33 34 35 36 41
1d 6b 49 08 41 30 32 33 34 35 36 41

## ⑥ Two-dimensional bar code commands

### Printing QR code

Name	Printing QR code
Code	ASCII : GS ( k pL pH cn fn m DEC : 29 40 107 pL pH cn fn m HEX : 1D 28 6b pL pH cn fn m
Function	Printing QR code
Parameter range	pL=3, pH=0 cn=49 fn=81 m=48
Default	None
Notes	Printing QR code. Users must consider QR code graph space. (The space of up and down, left and right of QR code graph is specified in the specification.)
Example	1b 40 1d 28 6b 03 00 31 43 03 1d 28 6b 03 00 31 45 30 1d 28 6b 06 00 31 50 30 41 42 43 1b 61 01 1d 28 6b 03 00 31 52 30 1d 28 6b 03 00 31 51 30

### Printing two dimensional code

Name	Printing two dimensional code
Code	ASCII : GS k m v r nL nH d1...dk DEC : 29 107 97 v r nL nH d1...dk HEX : 1D 6B 61 v r nL nH d1...dk
Function	Printing two dimensional code. v: describes two dimensional code specification v=0: describes automatically select two dimensional code specification



凱 勝 諾

廈門凱勝諾科技有限公司

XIAMEN CASHINO TECHNOLOGY CO.,LTD.

F,No.322 of 109 ,Tongji South Road,Jimei District,Xiamen,China.361021 ( Zongshun Business Building)  
Tel:+86-0592-5517253 Fax:+86-0592-5213815 E-mail:sales@csntek.com

	r: describes error correction rank nL nH: describes data length d1...dk: describes two dimensional code to be printed
Parameter range	$0 \leq v \leq 17$ $1 \leq r \leq 4$ $k = nL + 256 * nH$
Default	None
Notes	Printing QR code.
Example	1b 40 1D 6B 61 08 02 08 00 30 31 32 33 34 35 36 37

### Printing double QR code

Name	Printing double QR code
Code	ASCII : US Q m n p1H p1L I1H I1L ecc1 v1 d1...dn p2H p2L 12H I2L ecc2 v2 dk...dm DEC : 27 81 m n p1H p1L I1H I1L ecc1 v1 d1...dn p2H p2L 12H I2L ecc2 v2 dk...dm HEX : 1F 51 m n p1H p1L I1H I1L ecc1 v1 d1...dn p2H p2L 12H I2L ecc2 v2 dk...dm
Function	Printing double QR code
Range	QR code numbers: 0<m>3 QR code size: n(1~8) P1H,p1L specify the location of QR1: (p1H*256+p1L) L1H,I1L specify the data length of QR1: (I1H*256+I1L) Ecc1 specify error correction level about QR1: (0:7%, 1:15%,2:25%,3:30%) V1 specify QR1 version of the symbol.(1~40, 0:auto size) D1...d2 as the data of QR1; P2H,p2L specify the location of QR2: (p2H*256+p2L) L2H,I2L specify the data length of QR2: (I2H*256+I2L) Ecc2 specify error correction level about QR2: (0:7%, 1:15%,2:25%,3:30%) V2 specify QR2 version of the symbol.(1~40, 0:auto size) Dk...dm as the data of QR2
Default	None
Notes	If module size is bigger than printing width, the QR data will be treated as normal data
Example	To Print string "0123456789" in QR Code at position 32 with ecc 1and Print string "987654321" in QR Code at position 192 with ecc 2, and module size 3, you should send command as follow。 1f 51 02 03 00 20 00 0a 01 06 30 31 32 33 34 35 36 37 38 39 00 C0 00 0a 02 00 39 38 37 36 35 34 33 32 31 30



凱 勝 諾

厦门凯胜诺科技有限公司

XIAMEN CASHINO TECHNOLOGY CO.,LTD.

F,No.322 of 109 ,Tongji South Road,Jimei District,Xiamen,China.361021 ( Zongshun Business Building)  
Tel:+86-0592-5517253 Fax:+86-0592-5213815 E-mail:sales@csntek.com

## ⑦ Status querying Commands

### Real-time transmission status

Name	Real-time transmission status
Code	ASCII : DLE EOT n DEC : 16 4 n HEX : 10 04 n
Function	According to below parameters, transit the real-time status of printer,n stands for printer status: N=1:transmit printer status N=2:transmit off-line status N=3:transmit error status N=4:transmit paper sensor status
Range	$1 \leq n \leq 4$
Default	None
Support	All





# 厦门凯胜诺科技有限公司

XIAMEN CASHINO TECHNOLOGY CO.,LTD.

凱 勝 諾

F,No.322 of 109 ,Tongji South Road,Jimei District,Xiamen,China.361021 ( Zongshun Business Building)  
Tel:+86-0592-5517253 Fax:+86-0592-5213815 E-mail:sales@csntek.com

Notes

- Printer return to the relative status immediately after receiving the command
- this command try not to put in command list between 2 or more bite .

Though printer being forbid by ESC=,this command still effective.  
Printer transmit current situation ,each situation show by 1 bite data.  
It is not sure host computer will receive printer transmit situation.  
Printer executed immediately after received the command.  
The command only effective for serial printer.Printer start to work immediately after receiving this command at any situation.

n=1: printer status

Bit	0/ 1	Hexadecimal	Decimal	Function
0	0	00	0	Fixed to be 0
1	1	02	2	Fixed to be 1
2	0	00	0	Two drawers kick(no drawer, fixed to be 0)
	1	04	4	Turn off two cash drawer
3	0	00	0	On-line
	1	08	8	Off-line
4	1	10	16	Fixed to be 1
5,6		--	--	undefined
7	0	00	00	The paper has been torn away
	1	80	96	The paper hasn't been torn away

n=2: transit off-line status

bite	0 / 1	Hexadecimal	Decimal	Function
0	0	00	0	Fixed to be 0
1	1	02	2	Fixed to be 1



# 厦门凯胜诺科技有限公司

XIAMEN CASHINO TECHNOLOGY CO.,LTD.

F.No.322 of 109 ,Tongji South Road,Jimei District,Xiamen,China.361021 ( Zongshun Business Building)  
Tel:+86-0592-5517253 Fax:+86-0592-5213815 E-mail:sales@csntek.com

凱 勝 諾

2	0	00	0	Turn off upper cover
	1	04	4	Open upper cover
3	0	00	0	Not press feed key
	1	08	8	press feed key
4	1	10	16	Fixed to be 1
5	0	00	0	Paper adequate
	1	20	32	Paper shortage
6	0	00	00	No error
	1	40	64	Error
7	0	00	0	Fixed to be 0

n=3: transmit error status

bite	0	Hexadecimal	Decimal	Function
	/			
	1			
0	0	00	0	Fixed to be 0
1	1	02	2	Fixed to be 1
2		--	--	Undefined
3	0	00	0	No cutter error
	1	08	8	Cutter error
4	1	10	16	Fixed to be 1
5	0	00	0	No unrecoverable error
	1	20	32	Unrecoverable error
6	0	00	00	Printer head temp and voltage are normal
	1	40	64	Printer head temp.and voltage are exceed
7	0	00	0	Fixed to be 0

Unrecoverable error: abnormal input voltage

Automatic recovery error: refers to the printing head overheating error. When the



凱 勝 諾

# 厦门凯胜诺科技有限公司

## XIAMEN CASHINO TECHNOLOGY CO.,LTD.

F.No.322 of 109 ,Tongji South Road,Jimei District,Xiamen,China.361021 ( Zongshun Business Building)  
Tel:+86-0592-5517253 Fax:+86-0592-5213815 E-mail:sales@csntek.com

printing head overheating error occurs, wait for a period of time. When the printing head temperature drops, the error will be automatically recovered.

n=4: paper sensor status

bite	0	Hexadecimal	Decimal	Function
	/			
1				
0	0	00	0	Fixed to be 0
1	1	02	2	Fixed to be 1
2, 3	0	00	0	Paper
	1	0C	12	Paper near-end
4	1	10	16	Fixed to be 1
5, 6	0	00	0	Paper
	1	60	96	Paper end
7	0	00	0	Fixed to be 0

Example

10 04 01  
10 04 02  
10 04 03  
10 04 04

### ⑧ Other commands

#### Printer reset

Name	Printer reset
Code	ASCII : ESC @ Decimal : 27 64 Hex : 1B 40
Function	The ESC @ command initializes the printer as following: This command prints the data contained in the print buffer, and initializes various setup items. Restore default values for each parameter



凱 勝 諾

# 厦门凯胜诺科技有限公司

## XIAMEN CASHINO TECHNOLOGY CO.,LTD.

F,No.322 of 109 ,Tongji South Road,Jimei District,Xiamen,China.361021 ( Zongshun Business Building)  
Tel:+86-0592-5517253 Fax:+86-0592-5213815 E-mail:sales@csntek.com

Range	None
Default value	None
Notes	None
Example	None

### Print self-test page

Name	Print self-test page
Code	ASCII : DC2 T Decimal : 18 84 Hex : 12 54
Function	Printing a self-test page which including firmware version,interface,code page and other some information
Range	None
Default value	None
Notes	None
Example	1B 40 12 54

### Paper cut

Name	paper cut								
Code	① ASCII : GS V m Decimal : 29 86 m Hex : 1D 56 m ② ASCII : GS V m n Decimal : 29 86 m n Hex : 1D 56 m n								
Function	This command executes paper cutting The relationship between parameter m and the cut mode is as follows: <table border="1" style="margin-left: 20px;"> <thead> <tr> <th>M</th> <th>Mode</th> </tr> </thead> <tbody> <tr> <td>0, 48</td> <td>Full cut</td> </tr> <tr> <td>1, 49</td> <td>Partial cut</td> </tr> <tr> <td>65,66</td> <td>Feed paper and cut</td> </tr> </tbody> </table>	M	Mode	0, 48	Full cut	1, 49	Partial cut	65,66	Feed paper and cut
M	Mode								
0, 48	Full cut								
1, 49	Partial cut								
65,66	Feed paper and cut								
Range	① m = 0, 48, 1, 49 ② m = 66, 0 ≤ n ≤ 255								
Default value	None								
Notes	This command is valid only at the beginning of the line <ul style="list-style-type: none"> <li>• m = 0, 48, 1, 49, Printer cut paper directly。</li> <li>• m = 65,66, Feeds paper to[ The distance between the print position and the cutter + n × (vertical motion unit) ]and cuts the paper</li> <li>• Moving units horizontally and vertically are set by the GS p command</li> </ul>								



凱 勝 諾

# 厦门凯胜诺科技有限公司

## XIAMEN CASHINO TECHNOLOGY CO.,LTD.

F,No.322 of 109 ,Tongji South Road,Jimei District,Xiamen,China.361021 ( Zongshun Business Building)  
Tel:+86-0592-5517253 Fax:+86-0592-5213815 E-mail:sales@csntek.com

	• The feed volume is calculated by moving units vertically.
Example	1B 40 30 30 30 0D 0A 1D 56 00 30 30 30 0D 0A 1D 56 01 30 30 30 0D 0A 1D 56 42 00

### Full cut

Name	Full cut
Code	ASCII : ESC i Decimal : 27 105 Hex : 1B 69
Function	Full cut mode
Range	None
Default value	None
Notes	None
Example	1B 40 30 30 30 0D 0A 1B 69

### Partial cut

Name	Partial cut
Code	ASCII : ESC m Decimal : 27 109 Hex : 1B 6D
Function	Partial cut mode
Range	None
Default value	None
Notes	None
Example	1B 40 30 30 30 0D 0A 1B 6D