

REV.	DATE	ECN NO.	MODIFICATION	APPROVER
A	2012/05/14	/	NEW	Vicky

NOTES:

- MATERIAL: SEE TABLE
- SPECIALITY:
  - Rated current: 1.0A
  - Rated voltage: 30V
  - Contact Resistance: 50mohm MAX
  - Insulation Resistance: 1000Mohm MIN 500V DC
  - Dielectric withstanding voltage: 500V DC.
  - Solder ability: 250±5°C, 10±0.5s.
  - Durability: 3000 Cycles
  - Mating and Unmating force  
Insertion Force 10N Max; Withdrawal Force 2N Min
- COPLANARITY: BEFORE IR 0.10mm Max  
AFTER IR 0.12 mm Max
- PLEASE CONTACT JITS SALES REPRESENTATIVE TO VERIFY PRODUCT DETAILS & AVAILABILITY

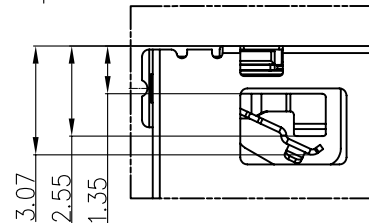
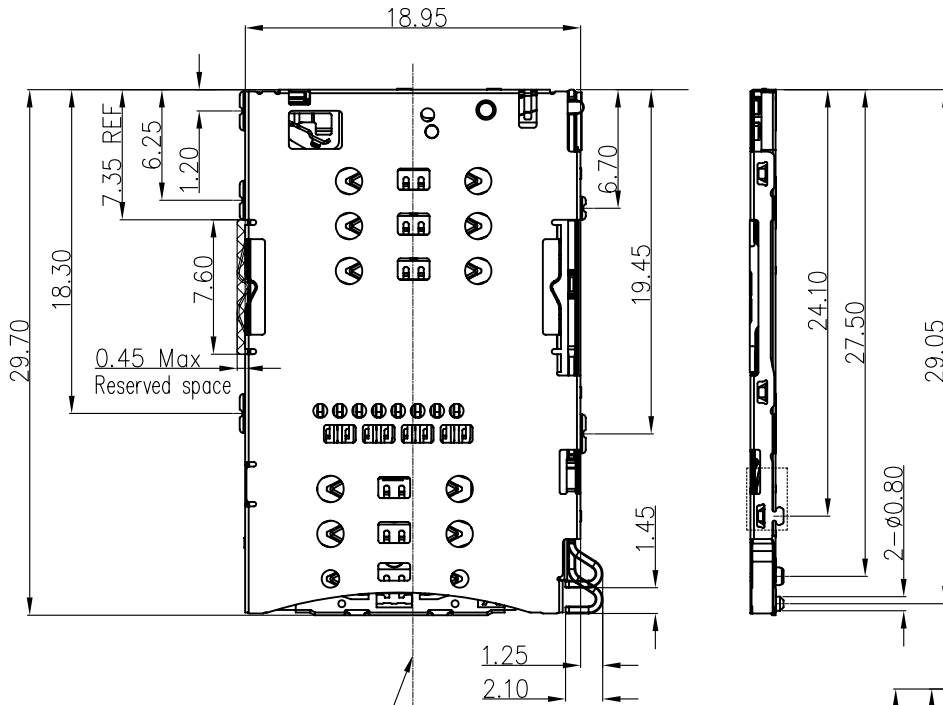

DETAIL: A  
SCALE: 2:1

6	CD PIN	1PCS	COPPER ALLOY
5	BAR	1PCS	STAINLESS STEEL
4	LEVER	1PCS	STAINLESS STEEL
3	SHELL	1PCS	STAINLESS STEEL
2	TERMINAL	1SET	COPPER ALLOY
1	HOUSING	1PCS	THERMOPLASTIC BLACK UL94-V0
NO.	PART NAME	QUANTITY	COLOR/MATEIAL

Center for connector      Center for Tray

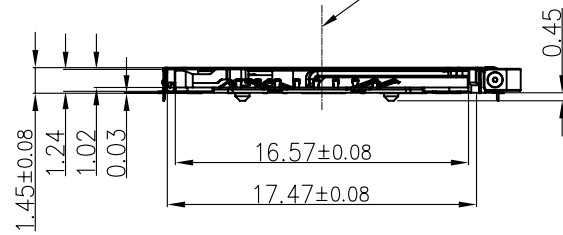

GENERAL TOLERANCE			UNITS	mm	NAME:	CARD	深圳市爱特姆科技有限公司 SHENZHEN ATOM TECHNOLOGY CO., LTD.		
SELECT	TOL.	1	2	3	MAT'L	PART NO:	TH02A-08201		
ON.						APPD:	Vicky		
X.XXX			±0.05	±0.15	FINISH	CHKD:	Doris		
X.XX		±0.15	±0.13	±0.25	Q'TY	DR:	Iris		
X.X		±0.20	±0.25	±0.50			DWG NO. ATOM-A03277		
X.			±0.38	±1.00			SCALE SHEET REV 1:1 1/3 A		
ANGLE		±3°							

REV.	DATE	ECN NO.	MODIFICATION	APPROVER
A	2012/05/14	/	NEW	Vicky

Micro SIM Circuit Description:

PIN No.	FUNCTION
C1	VCC
C2	RST
C3	CLK
C4	RESERVED
C5	GND
C6	VPP
C7	I/O
C8	RESERVED

Nano SIM Circuit Description:

PIN No.	FUNCTION
C1	VCC
C2	RST
C3	CLK
C4	RESERVED
C5	GND
C6	VPP
C7	I/O
C8	RESERVED

Micro SD Circuit Description:

PIN No.	FUNCTION
S1	DAT2
S2	CT/DAT3
S3	CMD
S4	VDD
S5	CLK
S6	VSS
S7	DAT0
S8	DAT1

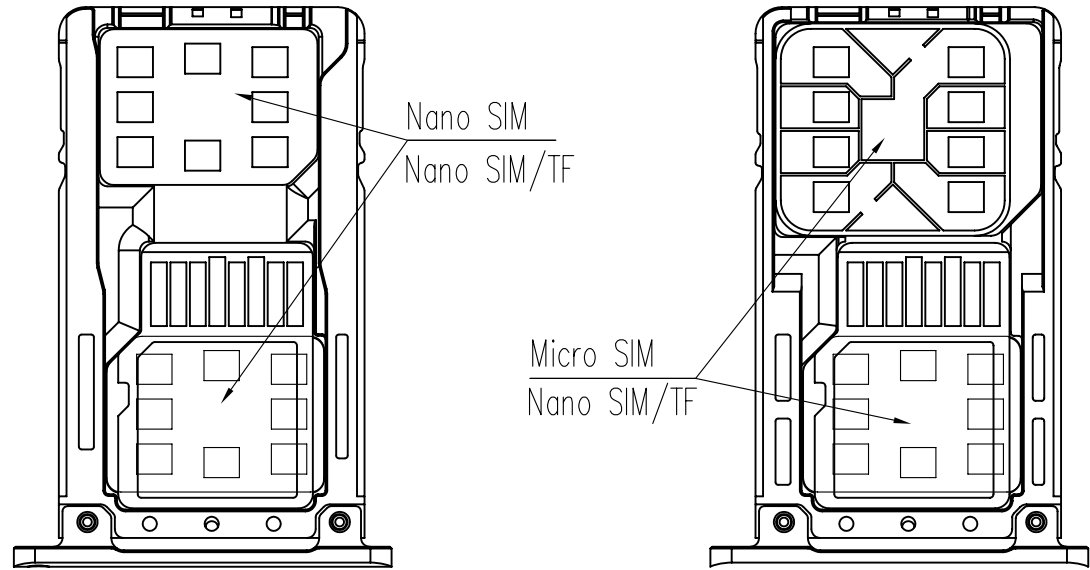
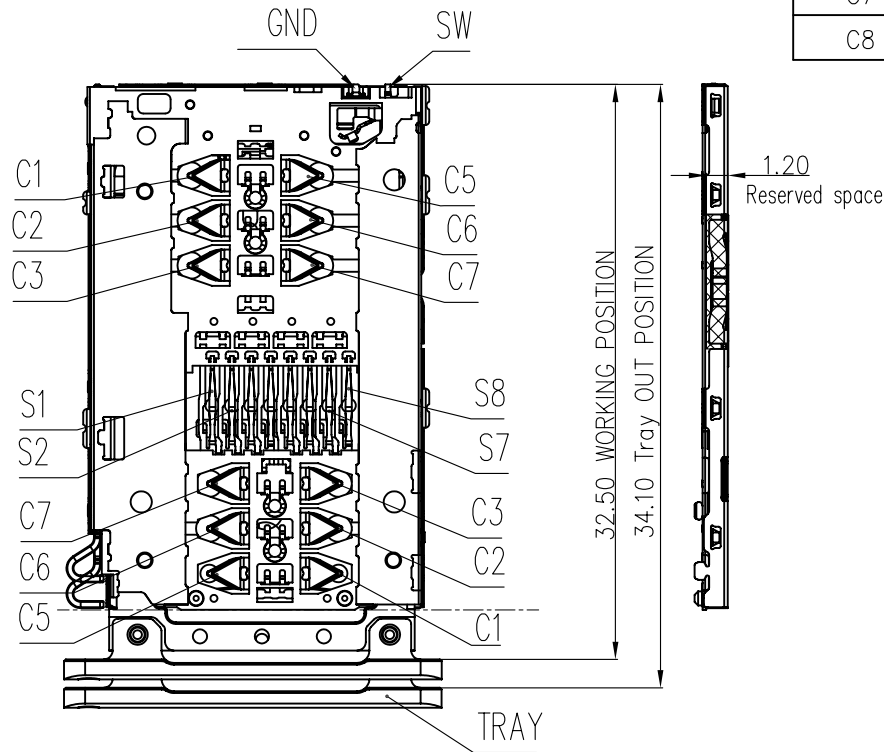
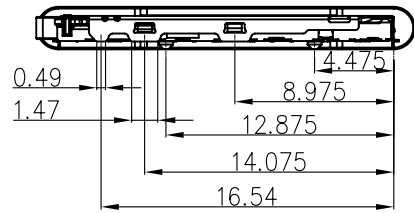

SW Circuit Description for Connector:

CARD INSERTION STATE	DETECT SWITCH CIRCUIT STATE	SCHEMATIC
TRAY UNMATED	OPENED	DETECT PIN SW  GND
TRAY MATED	CLOSED	DETECT PIN SW  GND

GENERAL TOLERANCE		UNITS	mm	NAME:	CARD	<b>ATOM</b> <sup>®</sup> 深圳市爱特姆科技有限公司 SHENZHEN ATOM TECHNOLOGY CO., LTD.			
SELECT	✓			PART NO:	TH02A-08201	TITLE:			
TOL.	1	2	3	APPD:	Vicky	DWG NO.			
ON.				CHKD:	Doris	ATOM-A03277			
X.XXX		±0.05	±0.15	DR:	Iris		SCALE	SHEET	REV
X.XX	±0.15	±0.13	±0.25				1:1	2/3	A
X.X	±0.20	±0.25	±0.50						
X.		±0.38	±1.00						
ANGLE	±3°								

REV.	DATE	ECN NO.	MODIFICATION	APPROVER
A	2012/05/14	/	NEW	Vicky

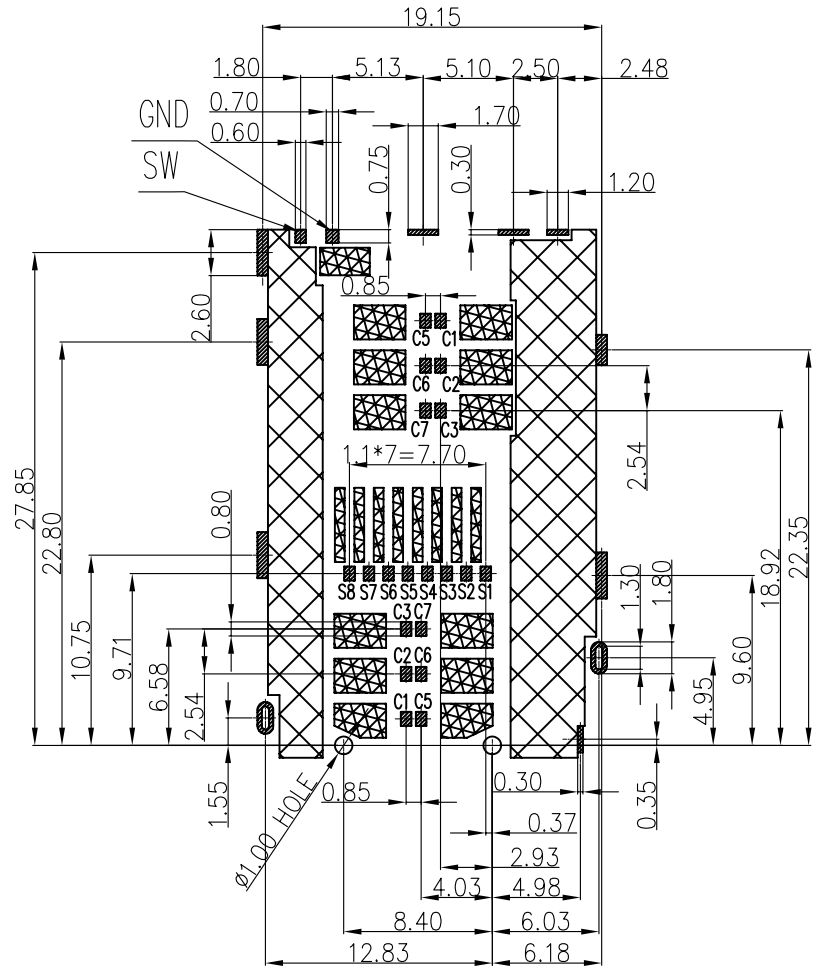

RECOMMENDED PCB LAYOUT TOP VIEW (TOLERANCE: ±0.05)

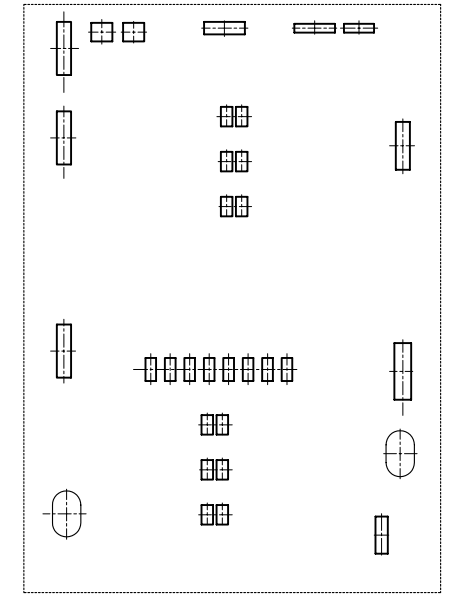
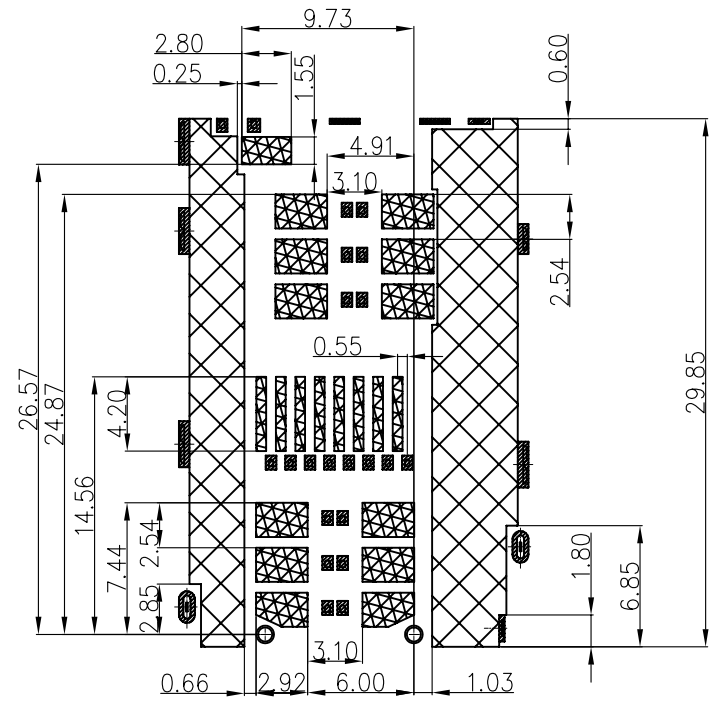

RECOMMENDED METAL MASK HOLE

RECOMMENDED METAL MASK T=0.12MM

- THESE AREA SHOULD BE FREE OF ANY CONDUCTIVE TRACES.
- SMT SOLDER AREA.
- KEEP OUT AREA (No Circuit)

GENERAL TOLERANCE			UNITS	mm	NAME:	CARD	<b>ATOM</b> <sup>®</sup> 深圳市爱特姆科技有限公司 SHENZHEN ATOM TECHNOLOGY CO., LTD.
SELECT	TOL.	✓	MAT'L		PART NO:	TH02A-08201	
ON.	1	2	3		APPD:	Vicky	DWG NO.
X.XXX		±0.05	±0.15		CHKD:	Doris	ATOM-A03277
X.XX	±0.15	±0.13	±0.25		DR:	Iris	
X.X	±0.20	±0.25	±0.50				
X.		±0.38	±1.00				
ANGLE	±3°						

	SCALE	SHEET	REV
	1:1	3/3	A